

# Wi-Fi Unleashed: Wi-Fi 7, 6 GHz, and Beyond

Carlos Cordeiro, PhD  
Intel Fellow and Wireless CTO (Client Computing Group)  
Intel Corporation

June 2022



intel®

# Agenda

## Background and Introduction

### Recap of Wi-Fi 6/6E

- Technical Highlights
- Wi-Fi 6E: Wi-Fi in 6 GHz

## Introduction to Wi-Fi 7

### Wi-Fi 7 In-Depth Review

- Key PHY Enhancements
- Multi-link Operation
- Enhanced QoS Management

## Beyond Wi-Fi 7

# Agenda

## Background and Introduction

### Recap of Wi-Fi 6/6E

- Technical Highlights
- Wi-Fi 6E: Wi-Fi in 6 GHz

## Introduction to Wi-Fi 7

### Wi-Fi 7 In-Depth Review

- Key PHY Enhancements
- Multi-link Operation
- Enhanced QoS Management

## Beyond Wi-Fi 7

# The Wireless World in 2030

BLE - Bluetooth low energy  
C-V2X - Cellular vehicle to everything  
LP-WAN - Low power wide area network  
mmWave - Millimeter wave spectrum

PWN - Private wireless networks  
SAT - Satellite  
UWB - Ultra wideband



The future is a mix of heterogenous wireless technologies: no one size fits all!

# More Than Ever, Wi-Fi Impacts Our Daily Lives!

## (Sep 2020) USA Internet Demand Still High

**+73%**

Average devices active online at home during working hours (vs. Jan-2020)<sup>1</sup>

**+40%**

Average household broadband usage per month (YOY vs. Sep-2019)<sup>2</sup>

**+31%**

Peak upstream (videoconferencing) broadband traffic (vs. Mar-2020)<sup>3</sup>

## USA Internet Connectivity's Importance Will Continue to Increase

**+84%**

of USA businesses will increase WFH capacity post-pandemic<sup>5</sup>

**\$186B**

(\$2T) USA CARES Act funding available for telehealth & education remote learning<sup>6</sup>

## Wi-Fi's Role Is Rapidly Growing Globally

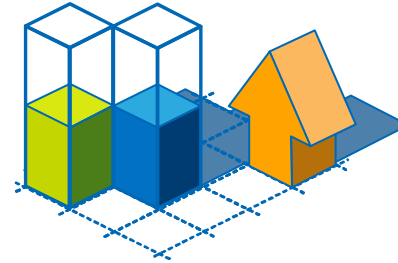

**51%**

of 2022 IP traffic is from Wi-Fi devices<sup>4</sup>

**59%**

of 2022 mobile data offloaded to Wi-Fi<sup>4</sup>

## Wi-Fi Products Leverage the Latest Technologies to Support Evolving User Needs

**Wi-Fi 6**  
2019

3x faster speeds<sup>7</sup>  
75% lower latency<sup>8</sup>  
4x device capacity<sup>9</sup>

**Wi-Fi 6E**  
2021

Broad gigabit speed enabling  
Reduced interference  
Improved responsiveness

**Wi-Fi 7**  
~2024

Nearly 5x faster speeds<sup>10</sup>  
Ultra-low latency  
Enhanced reliability

2020 highlighted Wi-Fi as the primary method for workers, students and families to connect

1 - 10: See slide 80 for a complete sources

# Wi-Fi Market Penetration and Economic Value

## Wi-Fi

by the numbers<sup>1</sup>

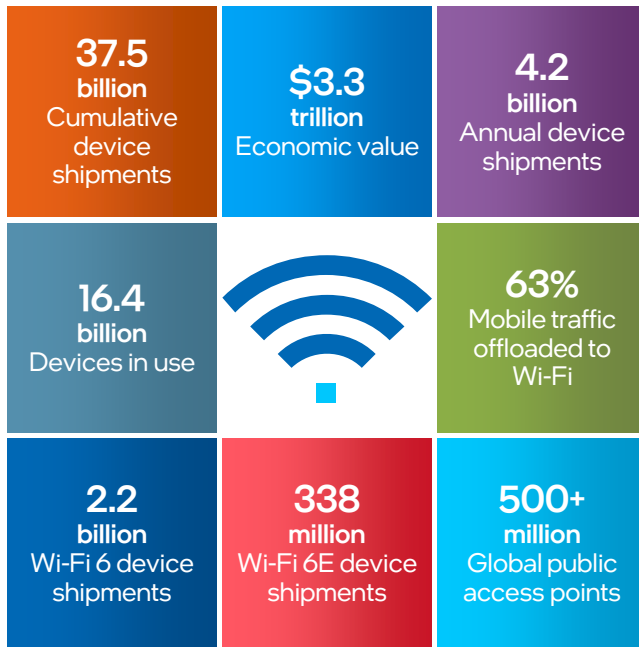

## Global Value of Wi-Fi<sup>1</sup>

**\$4.9 trillion**  
2025



2021  
**\$3.3 trillion**

## Wi-Fi chipset shipments<sup>2</sup>

Wi-Fi shipments at an all time high

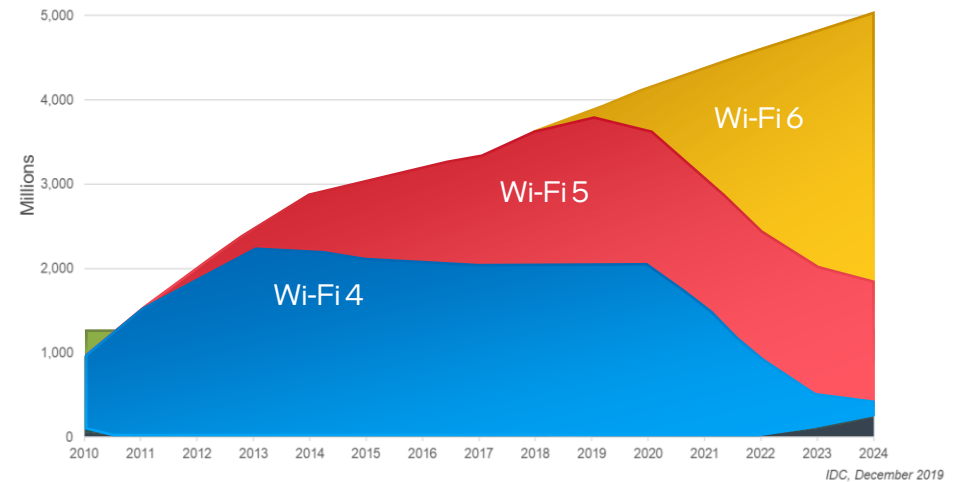

1. Wi-Fi Alliance® and Telecom Advisory Services for Wi-Fi Alliance®, 2021 (<https://www.wi-fi.org/discover-wi-fi/value-of-wi-fi>)

2. IDC, December 2019

# Current Generations of Wi-Fi

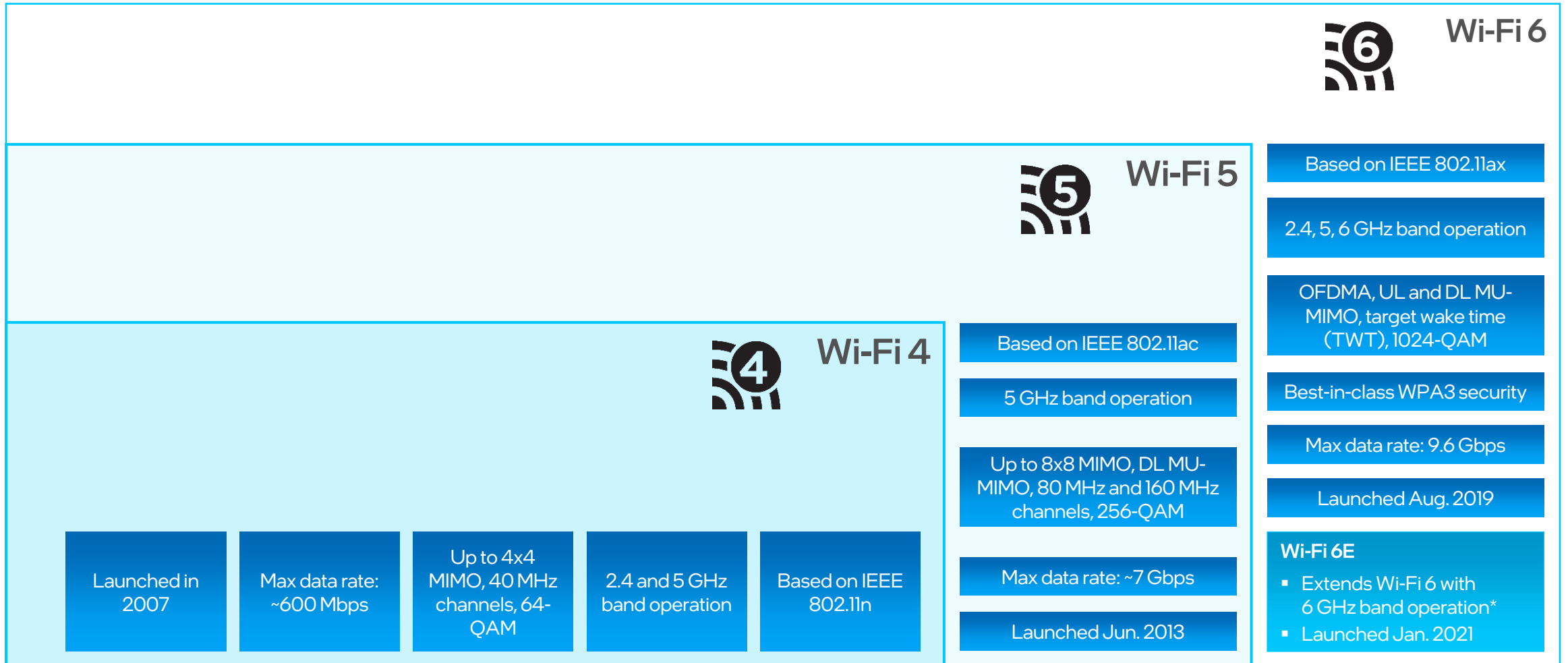

\* 6 GHz operation subject to regulatory rules in each country.



# Agenda

## Background and Introduction

### Recap of Wi-Fi 6/6E

- Technical Highlights
- Wi-Fi 6E: Wi-Fi in 6 GHz

## Introduction to Wi-Fi 7

### Wi-Fi 7 In-Depth Review

- Key PHY Enhancements
- Multi-link Operation
- Enhanced QoS Management

## Beyond Wi-Fi 7



# Wi-Fi 6: A Giant Leap Forward

## 4X

### Greater Scalability

OFDMA enables managed, reliable, efficient connectivity across more devices. This means plenty of headroom for future growth or fewer APs required to support existing devices.

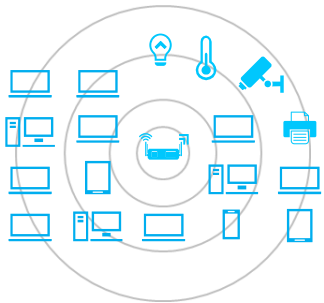

### Reduced Interference

OBSS enhancements help routers and devices identify local traffic and tune out noise from other networks.

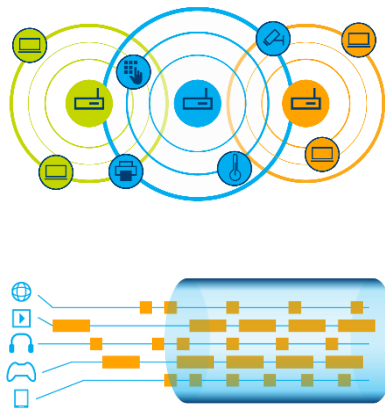

### Improved Security

Wi-Fi 6 uses new WPA3 security features, enabling next-generation authentication and best-in-class encryption.



## 3X

### Faster Performance

1024 QAM and support for optional 160 MHz channels enable clients and routers to deliver best-in-class Gigabit speeds for the office or home.

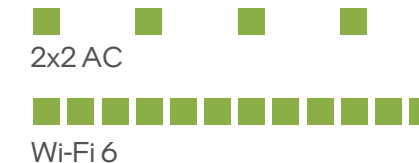

### Responsive!

## 75%

### Lower Latency

Wi-Fi 6 helps slash lag times to give you the edge you need to win with OFDMA data management and OBSS interference avoidance features.



Increasingly stringent usage (e.g., industrial IoT, AR/VR, robotics, cloud gaming) requirements demand continued evolution

# Wi-Fi 6: Path to a Truly Brilliant Wi-Fi

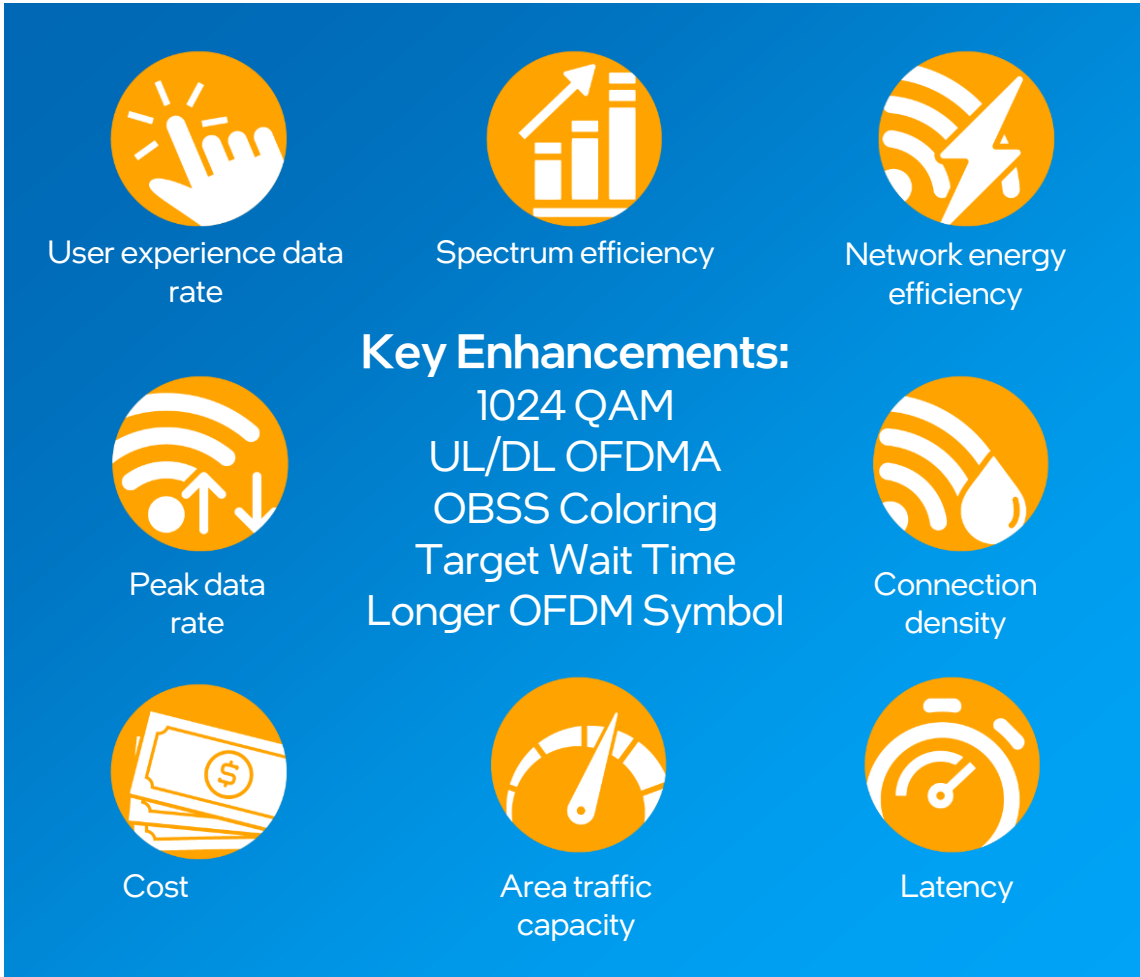

The diagram features a central blue box with the text "Key Enhancements:" followed by a list of technical improvements: 1024 QAM, UL/DL OFDMA, OBSS Coloring, Target Wait Time, and Longer OFDM Symbol. This central text is surrounded by nine orange circular icons, each with a white icon and a corresponding label below it. The icons represent: a hand pointing at a lightbulb (User experience data rate), a bar chart with an upward arrow (Spectrum efficiency), a lightning bolt with Wi-Fi waves (Network energy efficiency), a Wi-Fi signal with up and down arrows (Peak data rate), a Wi-Fi signal with a water drop (Connection density), a stack of money (Cost), a speedometer (Area traffic capacity), a Wi-Fi signal with a speedometer (Latency), and a Wi-Fi signal with a lightning bolt (implied high speed/efficiency).

**Key Enhancements:**

- 1024 QAM
- UL/DL OFDMA
- OBSS Coloring
- Target Wait Time
- Longer OFDM Symbol

User experience data rate

Spectrum efficiency

Network energy efficiency

Peak data rate

Connection density

Cost

Area traffic capacity

Latency

### Primary advancements

- New spectrum in the 6 GHz band
- Increased capacity, data rate
- Improved channel access and scheduling
- Enhanced interference mitigation
- Deterministic connectivity (QoS)
- Flexible power save

### Targeted usages



A collection of 18 blue icons arranged in three rows, representing various applications and devices that benefit from Wi-Fi 6. The icons include: a globe, a security camera, a cloud with a gear, a headset, a factory, a clock, an envelope, a game controller, a smartphone, a key, a building, a Wi-Fi router, a laptop, a battery, a washing machine, a laptop with a play button, and a refrigerator.

# Technical Highlights of Wi-Fi 6

Increase network efficiency by multiplexing users in frequency and space.

UL and DL OFDMA  
UL and DL MU-MIMO

Increase link efficiency with a 4x longer OFDM symbol and 1024-QAM.

Improved support for outdoor operation.

Improved performance over a wider range of implementation choices, e.g., large asymmetry in transmit power and number of antennas.

Peak data rate around 10 Gbps; best case latency around 1ms.

# OFDMA and MU-MIMO Efficiency Gains

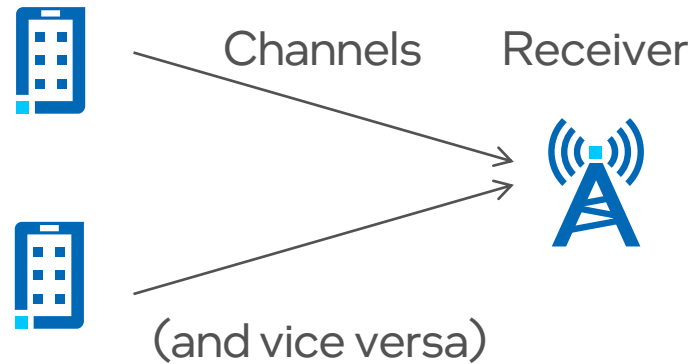

$$\text{Capacity} = \text{Channels} \times \text{Bandwidth} \times \text{Log}(1 + \text{Signal/Noise})$$

MU-MIMO increases the number of channels

Max bandwidth is unchanged with respect to  $\Pi_{ac}$

With multiple transmitters the total transmit power is increased

With UL OFDMA there is some cross-user leakage, but it is more than made up for by total power gain

With MU-MIMO cross stream noise increases, but it's inside the log function

# Increased Link Efficiency

Frequency domain  
(~5% gain)

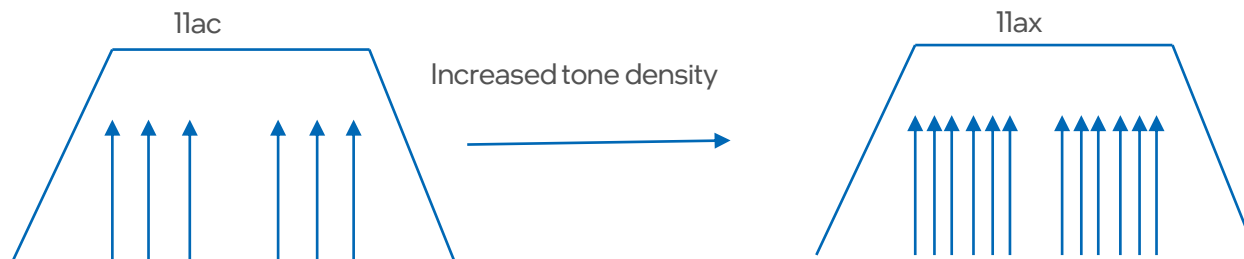

Squeeze more tones in around DC and edge, increased multipath resilience

Time domain  
(~15% gain)

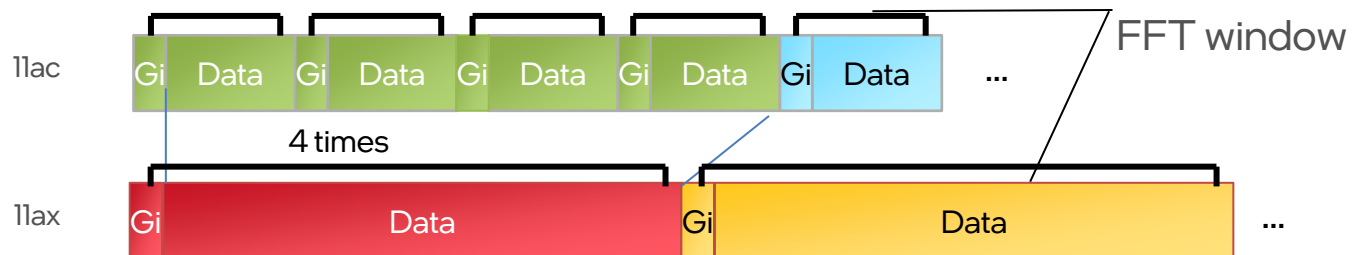

Guard interval (GI) overhead reduced

Modulation  
(~25% gain)

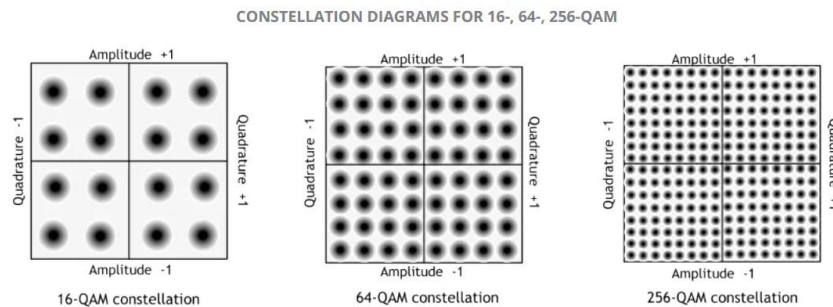

+ 1024-QAM

# Resource Unit (RU) Allocation

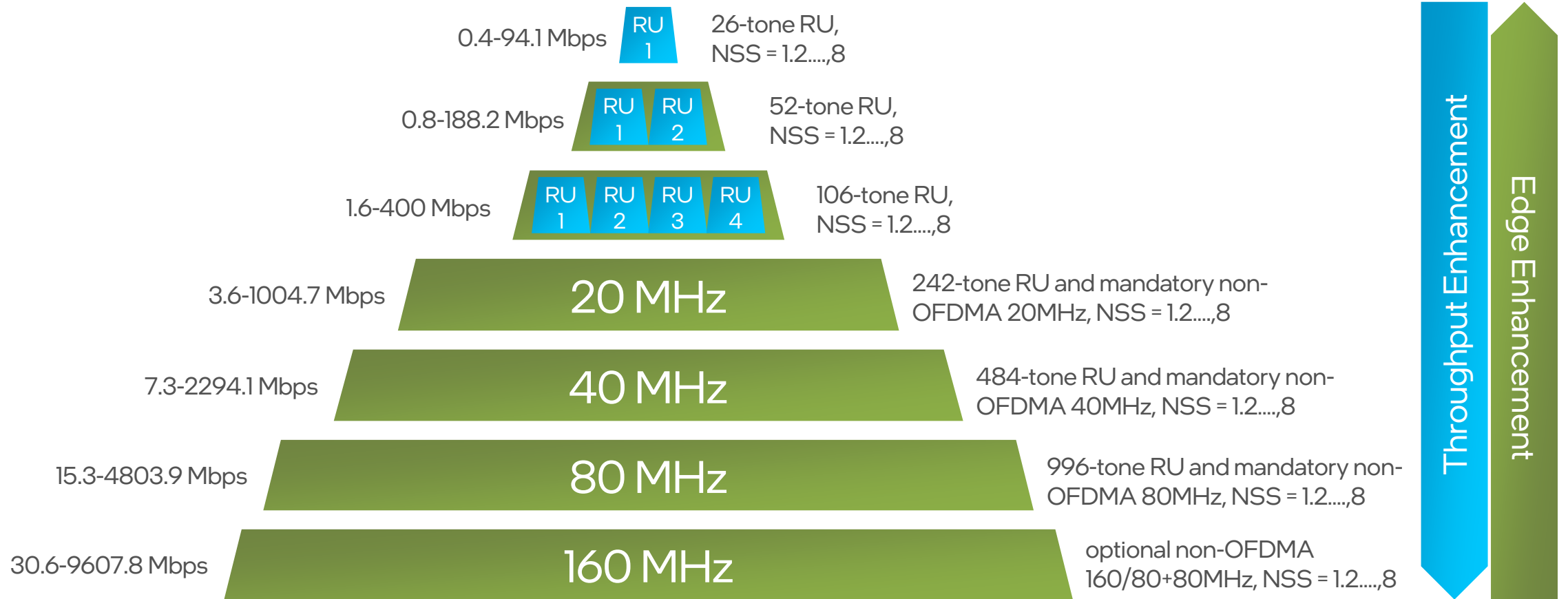

# RU Allocation vs. Number of Users\*

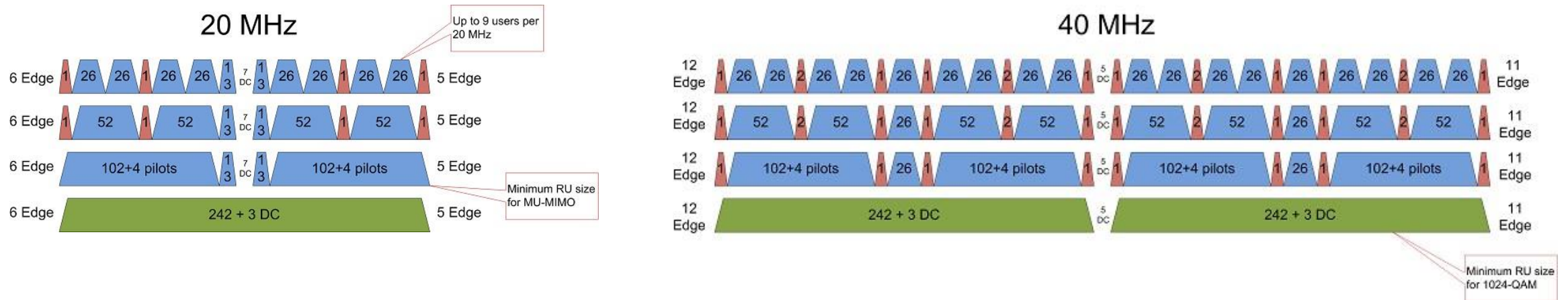

RU type	20 MHz	40 MHz	80 MHz	160 MHz and 80+80 MHz
26-subcarrier RU	9	18	37	74
52-subcarrier RU	4	8	16	32
106-subcarrier RU	2	4	8	16
242-subcarrier RU	1	2	4	8
484-subcarrier RU	N/A	1	2	4
996-subcarrier RU	N/A	N/A	1	2
2x996 subcarrier RU	N/A	N/A	N/A	1

\* This assumes OFDMA. The number of users can be increased by using MU-MIMO.

# Improved Outdoor Operation

Operates in higher delay spread channels than 11ac:

11ac GI options: 0.4  $\mu\text{s}$  and 0.8  $\mu\text{s}$

11ax GI options: 0.8  $\mu\text{s}$ , 1.6  $\mu\text{s}$  and 3.2  $\mu\text{s}$

GI overhead mitigated with longer (4x) OFDM symbol

Preamble includes repeated L-SIG.

Extended range preamble includes repeated HE-SIG-A.

Dual carrier modulation improves robustness in the Data field.



# Triggered UL Channel Access

- Until Wi-Fi 5, UL transmission is initiated by a STA by contending for the channel (AP has limited control of UL channel access).
- In Wi-Fi 6, triggered UL channel access is introduced, where an AP can control and schedule UL data transmissions from STAs.
  - Trigger frame is therefore introduced to allocate resources for and solicit one or more HE TB PPDU transmissions in the UL.
  - Depending on the specific use, different variants of the Trigger frame are defined.

Trigger frame variant	Primary use of the Trigger frame variant
Basic TF	Solicit HE TB PPDU in the UL for data transmission
Beamforming Report Poll (BFRP)	Solicit beamforming sounding feedback
MU-BAR	Solicit blockacks from multiple STAs
MU-RTS	Allow an AP to initiate a TXOP and protect the TXOP frame exchanges
Buffer Status Report Poll (BSRP)	Solicit buffer status report from STAs
GCR MU-BAR	Solicit Block Acks from multiple STAs in a GCR group
Bandwidth Query Report Poll (BQRP)	Solicit bandwidth query reports from STAs to assist an AP in allocating DL MU and UL MU resources
NDP Feedback Report Poll (NFRP)	Allow an HE AP to collect feedback that is not channel sounding from multiple STAs

# Data Exchange Sequences: Multi-user Downlink

- In 11ac, DL MU sequence acknowledgements are serialized.
- In 11ax, DL MU sequence acknowledgements are allocated UL resources and transmitted simultaneously.

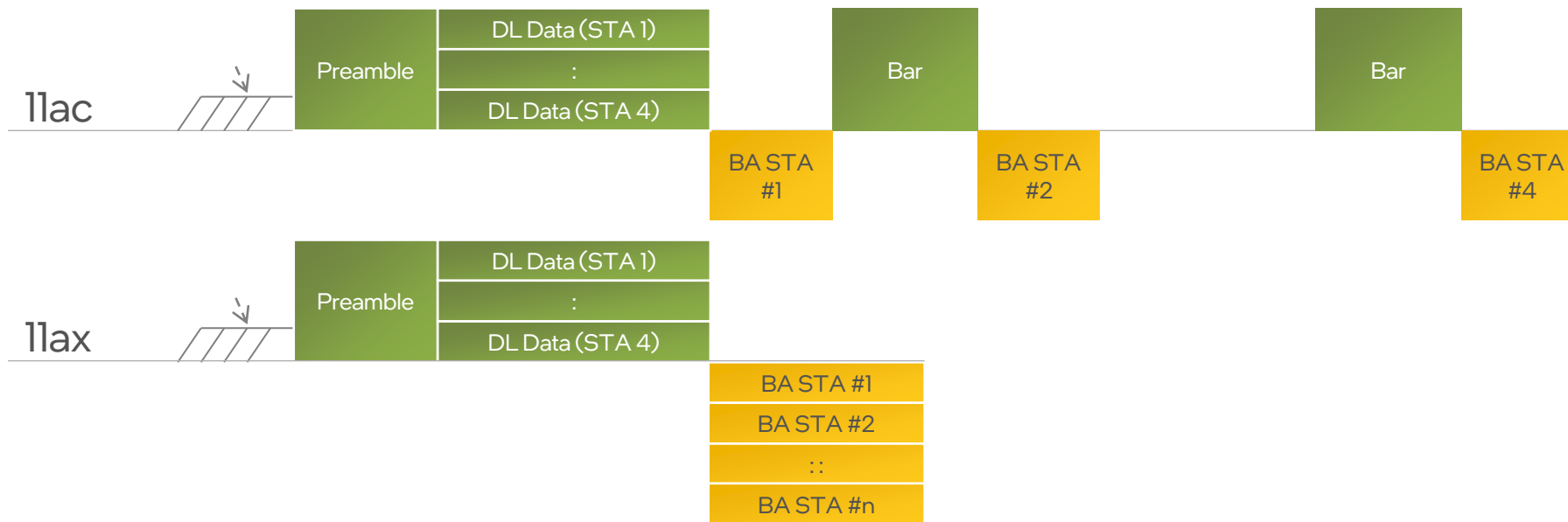

# Data Exchange Sequences: Multi-user Uplink

- In 11ac UL sequence, STAs compete for medium access and send sequentially.
- In 11ax UL sequence, the AP triggers simultaneous transmissions in multiple STAs.

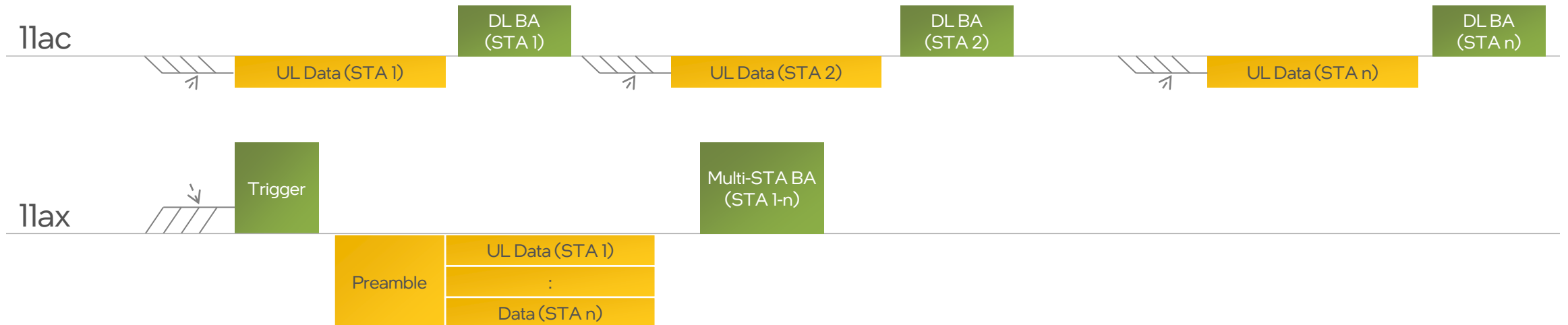

# Power Saving: Target Wake Time (TWT)

- TWT is designed to minimize the contention among STAs and save power.
- Allows a TWT requesting STA to negotiate with a peer TWT responding STA (e.g., AP) for the requesting STA to wake up periodically during a TWT Service Period (SP).
- The TWT requesting STA can doze any time except during the TWT SP intervals.
- Two types of TWT: individual TWT (negotiated) and broadcast TWT (distributed in Beacon).

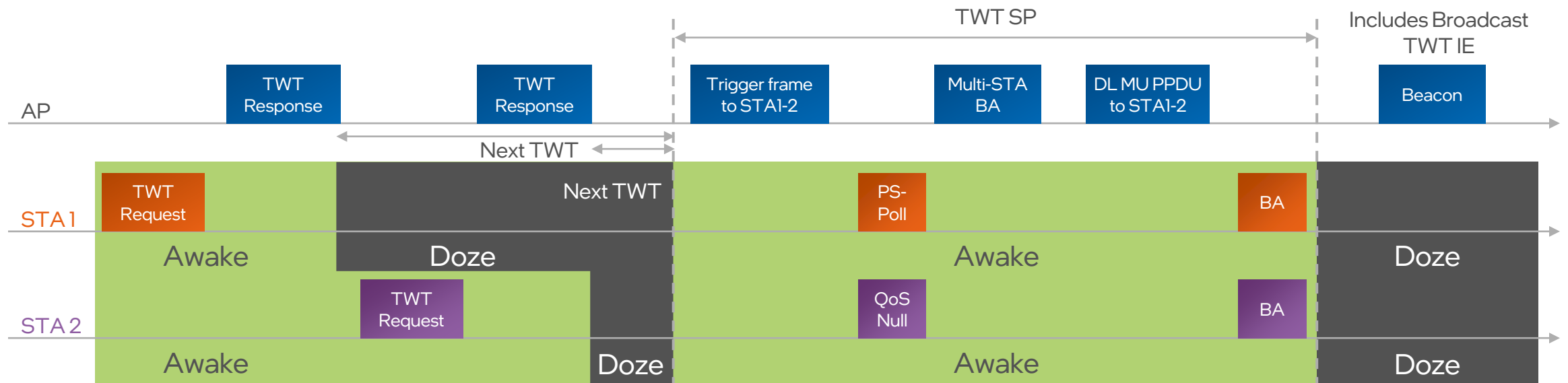

# Beamforming Sounding

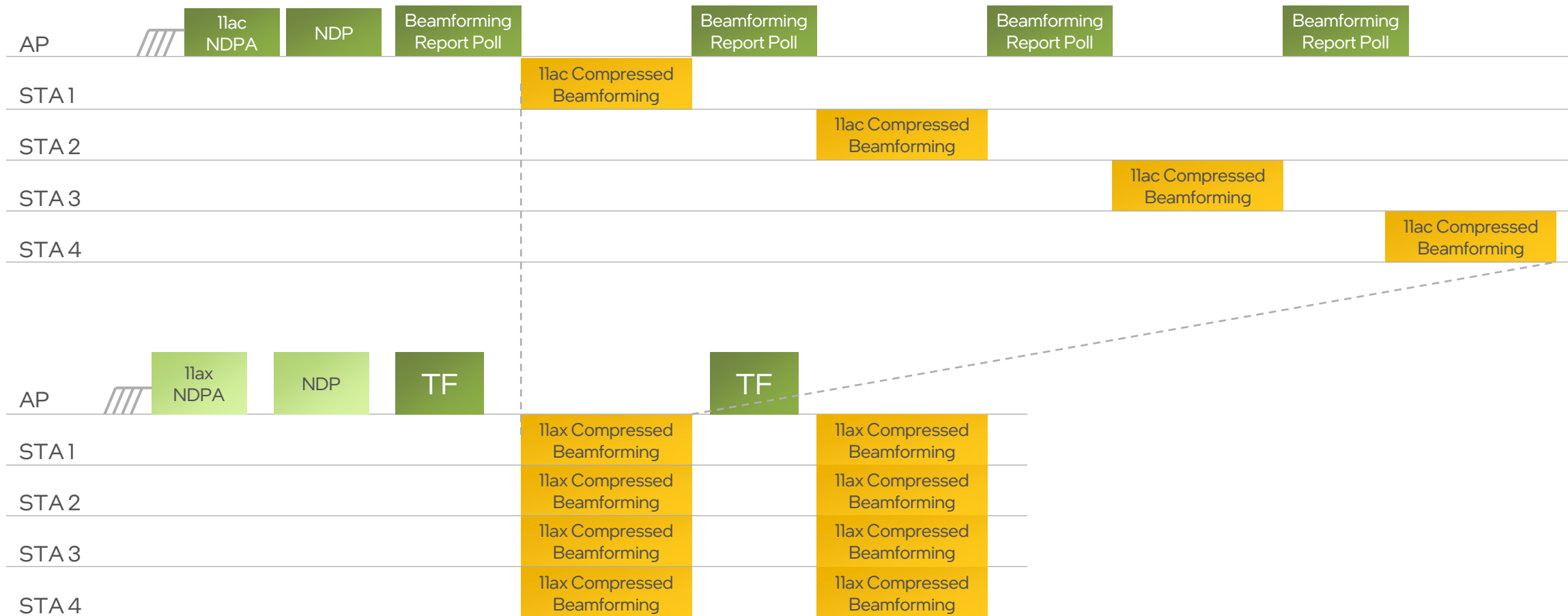

# Wi-Fi 6 Single User Throughput – Intel Lab

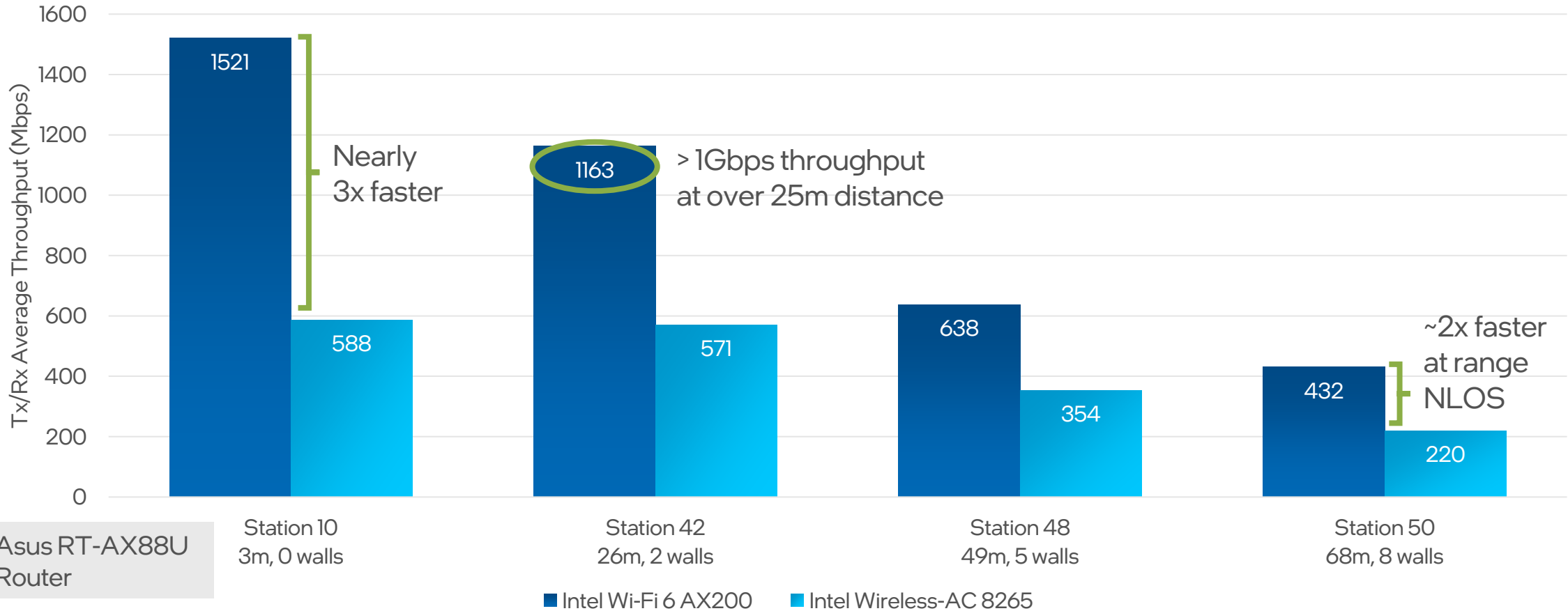

Wi-Fi 6 provides substantial performance improvement at all ranges

Single User Average Throughput: Platform: Dell Latitude 5491; Client Intel Wi-Fi 6 AX200, SW 21.0.0.4; OS: Windows 10; AP: Asus AX88U (BCM) FW3.0.0.4.384\_5640

# Wi-Fi 6 Multi-User Throughput – Intel Lab



As implementations mature, >4X capacity improvement for multi-user use cases can be expected

Single User Average Throughput: Platform: Dell Latitude 5491; Client Intel Wi-Fi 6 AX200, SW 21.0.0.4; OS: Windows 10; AP: Asus AX88U (BRCM) FW3.0.0.4.384\_5640

# Wi-Fi 6 Latency & Jitter – Intel Lab

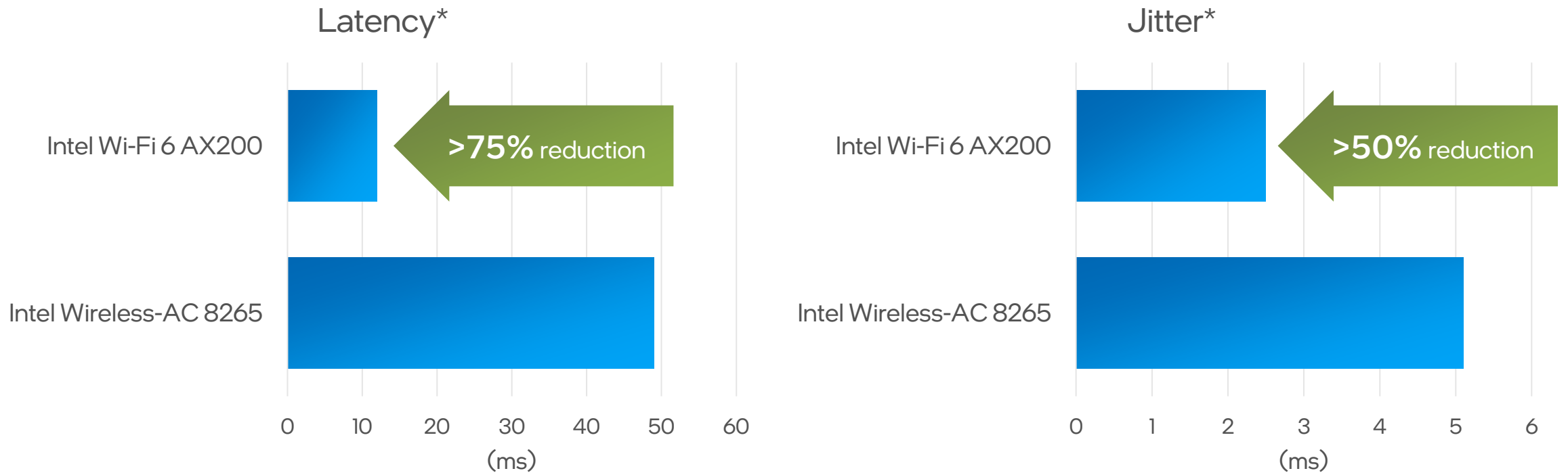

Lower latency improves real-time applications like VoIP and gaming  
Lower jitter improves the reliability of the network packets, reducing BER

\* Without optimization. With optimization (e.g., for TSN), figures can be reduced by more than 5 times



# Agenda

## Background and Introduction

### Recap of Wi-Fi 6/6E

- Technical Highlights
- Wi-Fi 6E: Wi-Fi in 6 GHz

## Introduction to Wi-Fi 7

### Wi-Fi 7 In-Depth Review

- Key PHY Enhancements
- Multi-link Operation
- Enhanced QoS Management

## Beyond Wi-Fi 7

# Evolution in Demand: Increase in Connected Device Density

## Expansion of Wi-Fi Devices & Usages:

Is creating congested networks with longer wait times, frequent buffering & glitchy applications

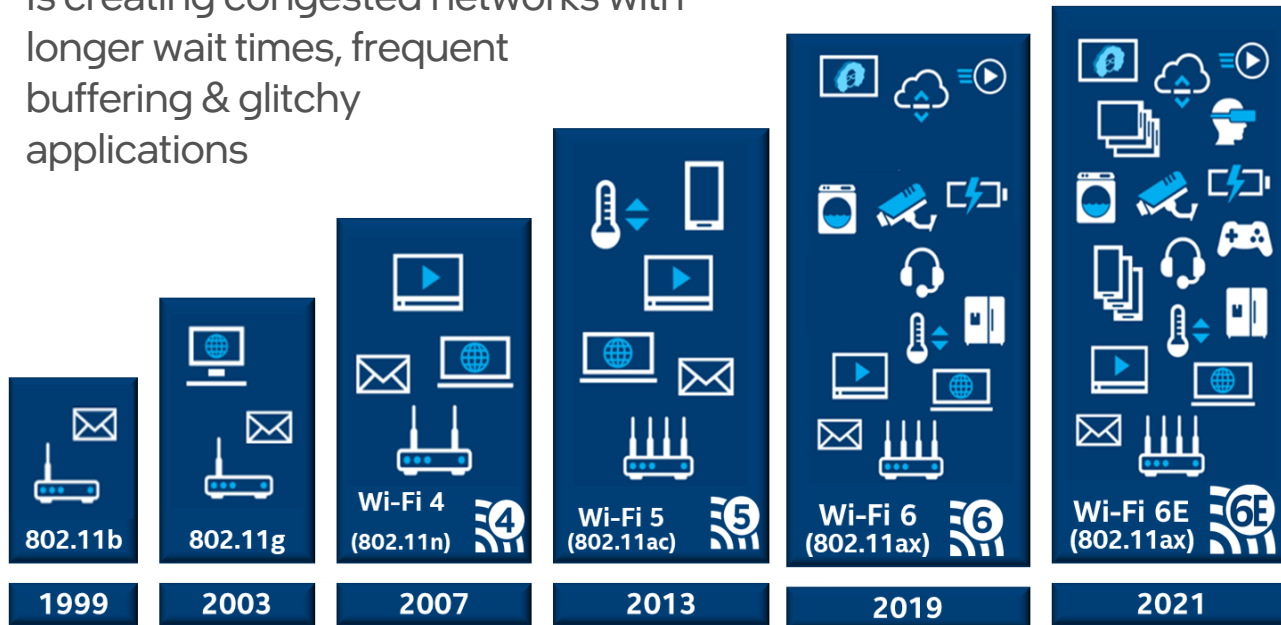

## New usages

- High-speed computing
- Cloud storage & backup
- Video calling
- 4K streaming
- Online gaming

## Intel Wi-Fi 6 (Launched in 19') provides:

- ~3x faster throughput
- ~4x network capacity
- ~75% lower latency



Wi-Fi 6 limited by spectrum & legacy devices

Wi-Fi 6E adds needed Spectrum to support the Wi-Fi 6 promise

Wi-Fi 6E: Meeting the evolving demands of the Wi-Fi network

# Introducing: Wi-Fi 6E

**6 GHz benefits are not for all Wi-Fi 6 devices**  
(Wi-Fi 6E = Device differentiation & backwards compatibility)

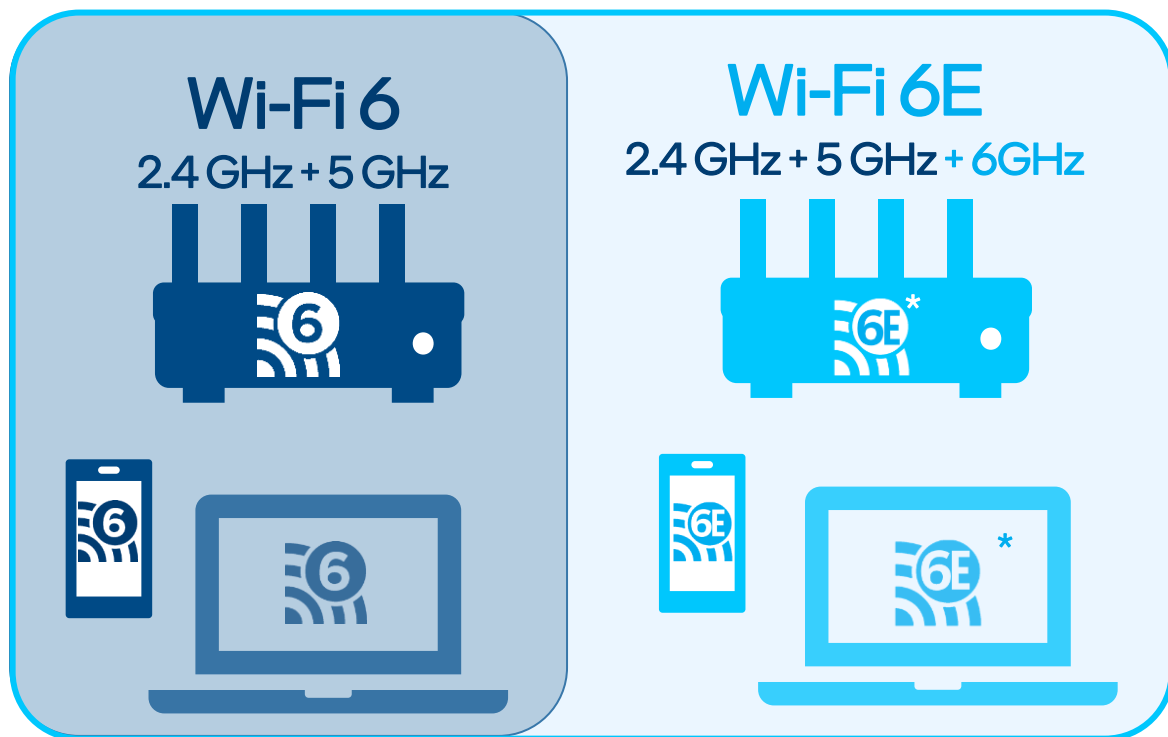

**With Wi-Fi 6E, the amount of spectrum used by Wi-Fi is almost 3X more**

## Comparing Wi-Fi Spectrum

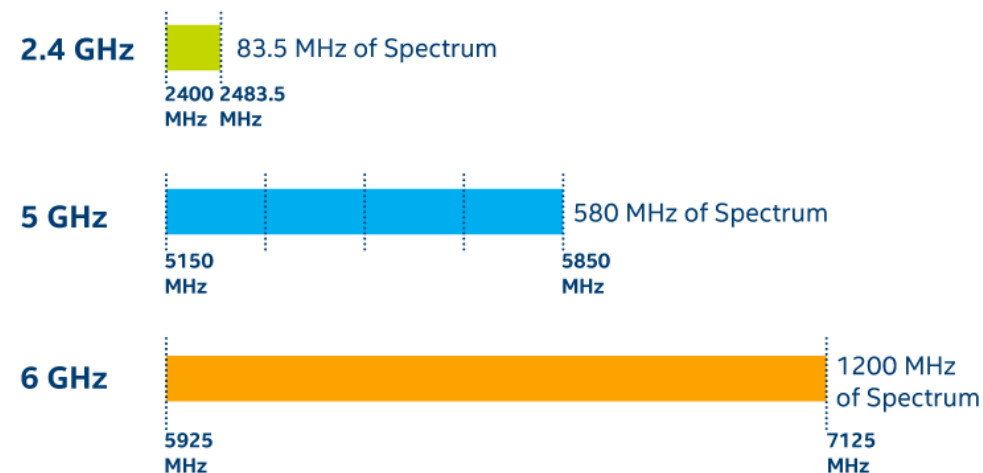

**Wi-Fi 6E: new spectrum brings the Wi-Fi 6 promise to reality, with compatibility to legacy Wi-Fi**

\* Not actual WFA Wi-Fi 6E logo

# Wi-Fi 6E: Highlights

## 6 GHz Features

### Huge contiguous clean spectrum

- 1200 MHz vs. 480 MHz (>2X)

### Many more Gigabit Wi-Fi options

- (7) vs. (2) 160 MHz channels

### Exclusive to new Wi-Fi 6 products

- No legacy devices (Wi-Fi 4 or 5)

## Comparing Wi-Fi Spectrum

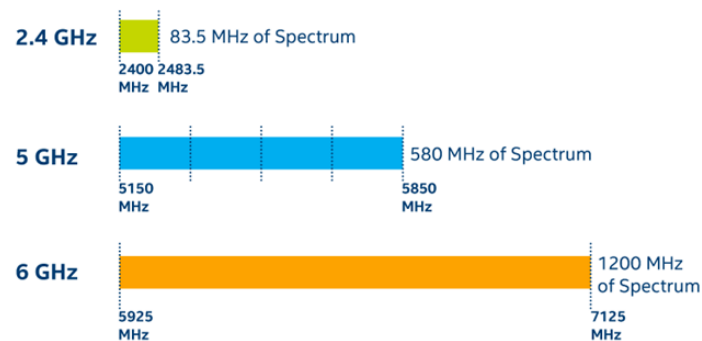

1) Cisco VNI Global IP Traffic Forecast 2017-22

## 6 GHz Benefits

### Greater network flexibility

- Ideal for dense environments

### Fast downloads/sharing/backups

- Gigabit speed = new normal

### Reduced latency + improved reliability

- No waiting on older/slower devices



## Why Is It Important?

### 1st new Wi-Fi spectrum in 17 years

- New 5 GHz DFS channels in 2003

### ~70% IP traffic on Wi-Fi by 2022<sup>1</sup>

- Billions of devices already on 5 GHz

### Delivers the max benefits of Wi-Fi 6

- Homogeneous "new" device networks

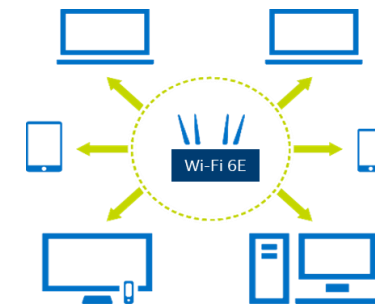

# 6 GHz Worldwide Regulatory Status

- Adopted 5925-6425 MHz
- Adopted 5925-7125 MHz
- Considering 5925-6425 MHz
- Considering 5925-7125 MHz
- ▨ Adopted 5925-6425 MHz, Considering 6425-7125 MHz

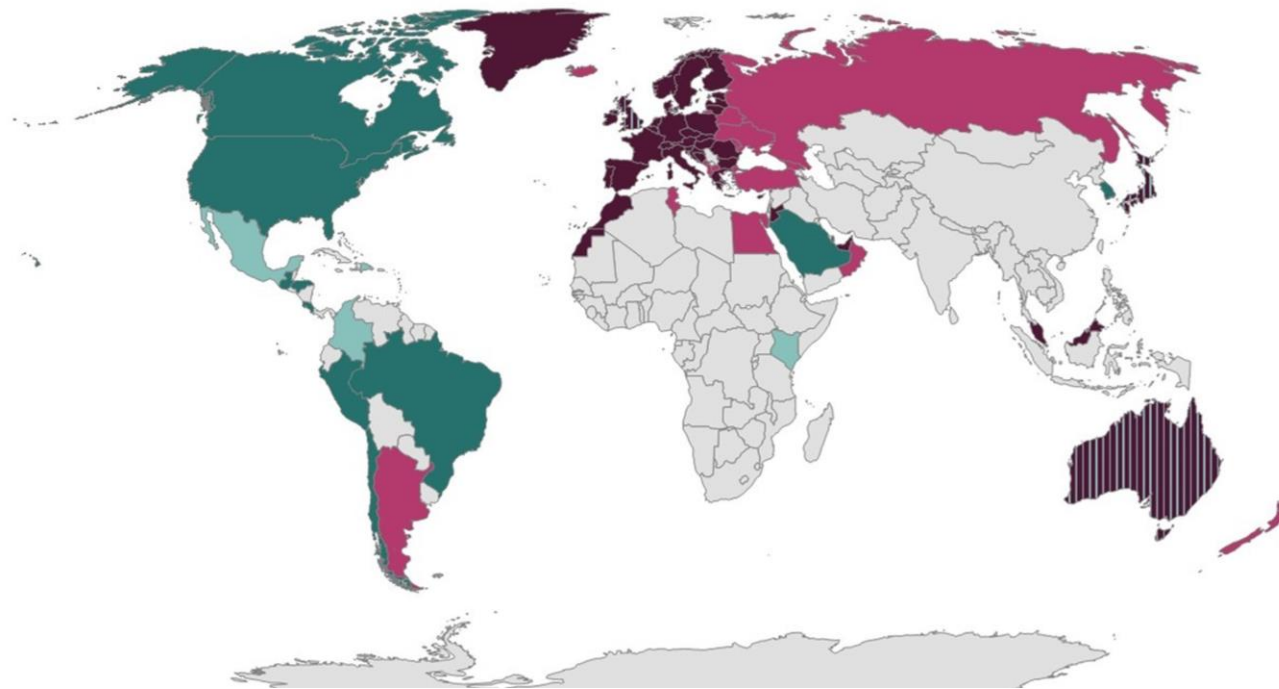

Source: [wi-fi.org/countries-enabling-wi-fi-6e](https://www.wi-fi.org/countries-enabling-wi-fi-6e)

- The 48 CEPT countries individually implement the European Commission's final decision to open spectrum for unlicensed. Some will proceed by consultations, while others will adopt the decision by an administrative change.
- The 27 European Union Member States, all of which are also CEPT members, will implement the European Commission's final decision to open spectrum for unlicensed on or before December 1<sup>st</sup>, 2021.
- African Telecommunications Union (ATU) recommended regulation close to that CEPT. African countries started adoption or considering.

# Equipment Classes for Unlicensed 6 GHz



Class	Power	Access Requirements
Indoor Low Power AP**	5 dBm/MHz	Indoor Use Only
Standard Power AP	36 dBm	AFC
Portable Client Device	6 dB below AP (= -1 dBm/MHz)	Under Control of Access Point
Client to Client Communications	-1 dBm/MHz*	Indoor Use Only; in Range of AP*
Very Low Power Portable AP*	14 dBm EIRP*	Very Low Power*

Class	Power	Access Requirements
Indoor Low Power AP	23 dBm	Indoor Use Only
Outdoor Standard Power AP	TBD	Registration/Light License on National Basis
Portable Client Device	23 dBm	Under Control of Access Point
Very Low Power Portable AP	14 dBm	Very Low Power

\* Seeking authorization under Further Notice of Proposed Rulemaking (FNPRM)

\*\* US LPI Rules based on 5 dBm/MHz PSD so that the larger the bandwidth, the greater the total power. FCC is now evaluating whether to increase LPI PSD to 8 dBm/MHz and 33 dBm total power for 320 MHz channel.

# Device Classes Proposed or Adopted

	LPI	Standard Power	VLP		LPI	Standard Power	VLP		LPI	Standard Power	VLP
US	●	●	●	CEPT/EU	●		●	South Korea	●	●	●
Brazil	●		●	UK	●		●	Japan			
Canada	●	●	●	UAE	●			India			
Mexico	●	●	●	Saudi Arabia	●	●	●	Australia	●	●	●
Argentina	●			Jordan	●		●	Singapore/ Indonesia			
Chile	●			Oman	●	●	●	Hong Kong			
Colombia	●		●	Qatar	●		●	Taiwan			
Peru	●			Egypt	●		●	Thailand	●		
Honduras	●			ATU	●	●	●	New Zealand	●	●	●
Costa Rica	●		●	Morocco	●	●	●	Malaysia	●	●	●
Guatemala	●			Tunisia	●	●	●	Tunisia	●	●	●

\*Low Power Indoor (LPI), Very Low Power (VLP, Indoor/outdoor), Standard Power (Indoor/Outdoor)

# Agenda

## Background and Introduction

### Recap of Wi-Fi 6/6E

- Technical Highlights
- Wi-Fi 6E: Wi-Fi in 6 GHz

## Introduction to Wi-Fi 7

### Wi-Fi 7 In-Depth Review

- Key PHY Enhancements
- Multi-link Operation
- Enhanced QoS Management

## Beyond Wi-Fi 7



# New Experiences Demand Continuous Improvement

## Traditional Network

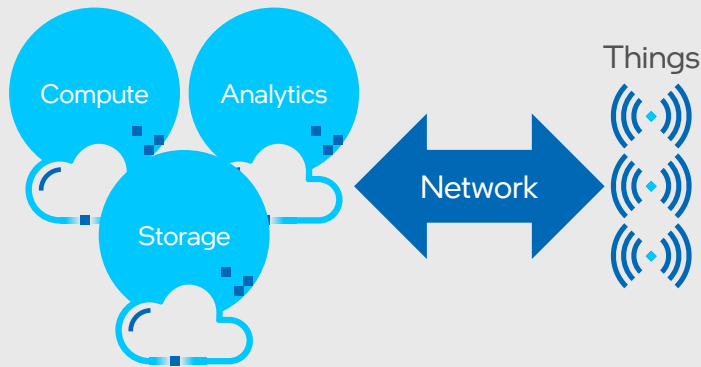

Distributed Intelligence (Multi-Cloud)

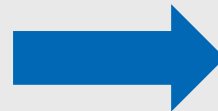

## Intelligent Network

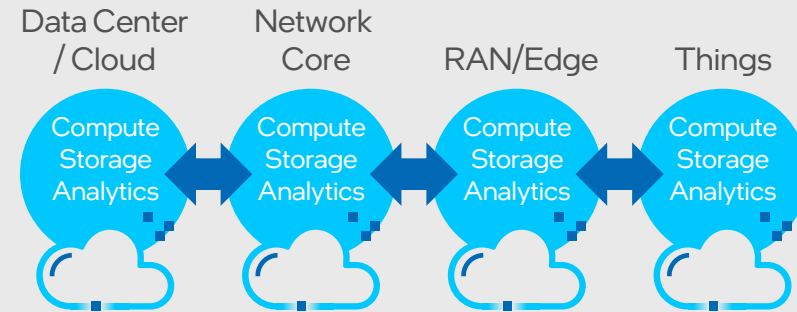

New experiences (e.g., industrial IoT, 3D/XR content, real-time collaboration) demand more responsive connectivity

Compute shifting closer to the user, thereby redefining end-to-end (E2E) network performance (e.g., low, single-digit and sub-1ms latency become broadly available)

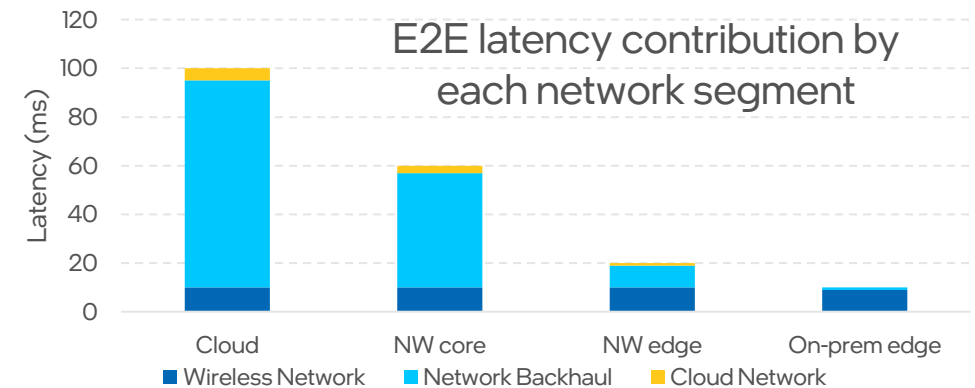

High performance wireless access is essential to meet growing demand

Latency Chart Source: Intel

# Up Next: Wi-Fi 7

## Based on IEEE P802.11be

### P802.11be project goals\*

- Amendment to 802.11, building on 11ax
- Maximum throughput of at least 30 Gbps
- Frequency range: 2.4, 5, 6 GHz
- Improvements to worst-case latency & jitter

### Targeted usages

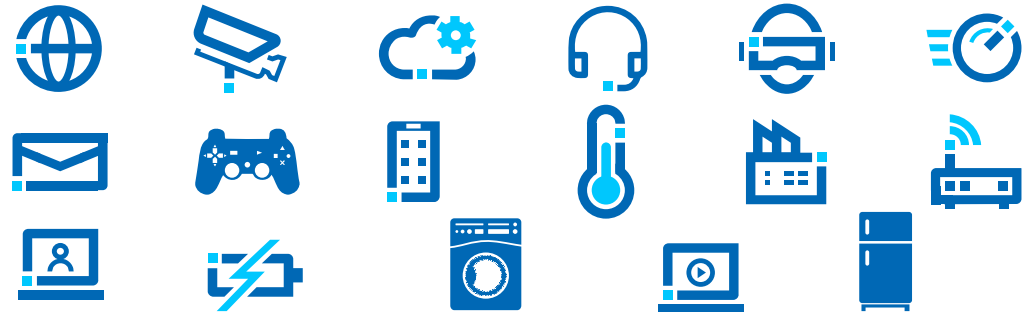

### Target timeline

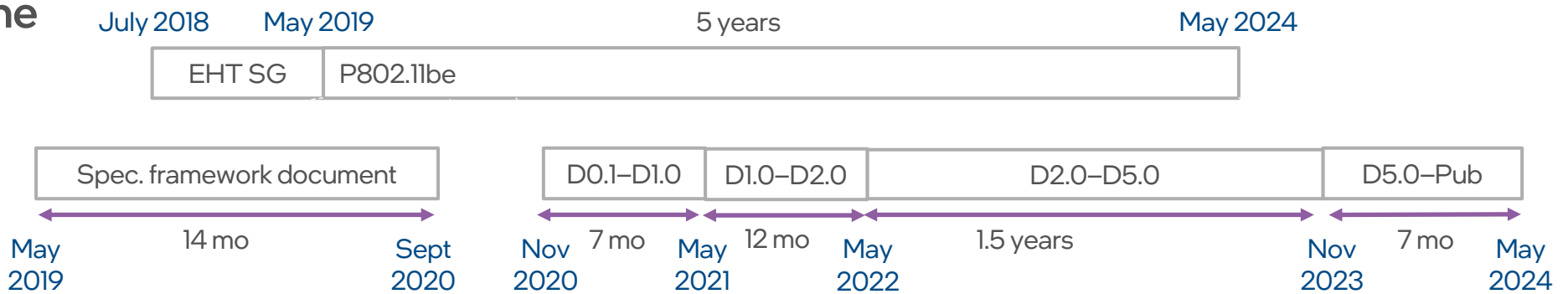

\* [http://www.ieee802.org/11/PARs/P802\\_11be\\_PAR\\_Detail.pdf](http://www.ieee802.org/11/PARs/P802_11be_PAR_Detail.pdf)

# Wi-Fi 7 : ~3.6x Faster<sup>1</sup> than Wi-Fi 6

Based on IEEE P802.11be<sup>2</sup>

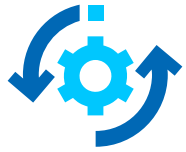

User Experience Data Rate



Spectrum Efficiency



Network Energy Efficiency

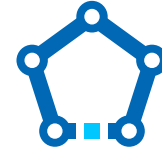

Connection Density

## Key Enhancements

320 MHz channels  
4096-QAM  
Multi-RU (puncturing)

Multi-link operation  
Deterministic low latency  
P2P operation



Peak Data Rate



Cost Effective



Area Capacity



Low Latency

<sup>1</sup> Includes PHY and multi-link data rate improvements

<sup>2</sup> [http://www.ieee802.org/11/PARs/P802\\_11be\\_PAR\\_Detail.pdf](http://www.ieee802.org/11/PARs/P802_11be_PAR_Detail.pdf); Accurate as of June/2022. Feature set and their specification are subject to change.

# Agenda

## Background and Introduction

## Recap of Wi-Fi 6/6E

- Technical Highlights
- Wi-Fi 6E: Wi-Fi in 6 GHz

## Introduction to Wi-Fi 7

## Wi-Fi 7 In-Depth Review

- Key PHY Enhancements
- Multi-link Operation
- Enhanced QoS Management

## Beyond Wi-Fi 7

# Wi-Fi 7 PHY Basics

Extends the Wi-Fi 6  
(802.11ax) PHY:

OFDMA based  
DL/UL MU-MIMO

Four types of PPDU:

Single user (SU) PPDU  
Multi-user (MU) PPDU  
Trigger-based (TB) PPDU  
Extended range (ER) SU  
PPDU

# Key PHY Enhancements for Wi-Fi 7

- Forward compatible preamble design: U-SIG
- Wider bandwidth: 320 MHz support
- Higher peak rate: 4096-QAM support and 16 spatial streams
- Enhanced resource allocation: Multiple resource units (RUs) allocation

	Wi-Fi 6	Wi-Fi 7
<b>Max channel bandwidth</b>	160 MHz	320 MHz
<b>Highest modulation order</b>	1024-QAM	4096-QAM
<b>Max no. of spatial streams</b>	8	8
<b>Max data rate</b>	~9.6 Gbps	~23 Gbps
<b>Resource allocation</b>	Single RU	Multi-RU

## Wi-Fi 7 vs. Wi-Fi 6 Data Rate Comparison

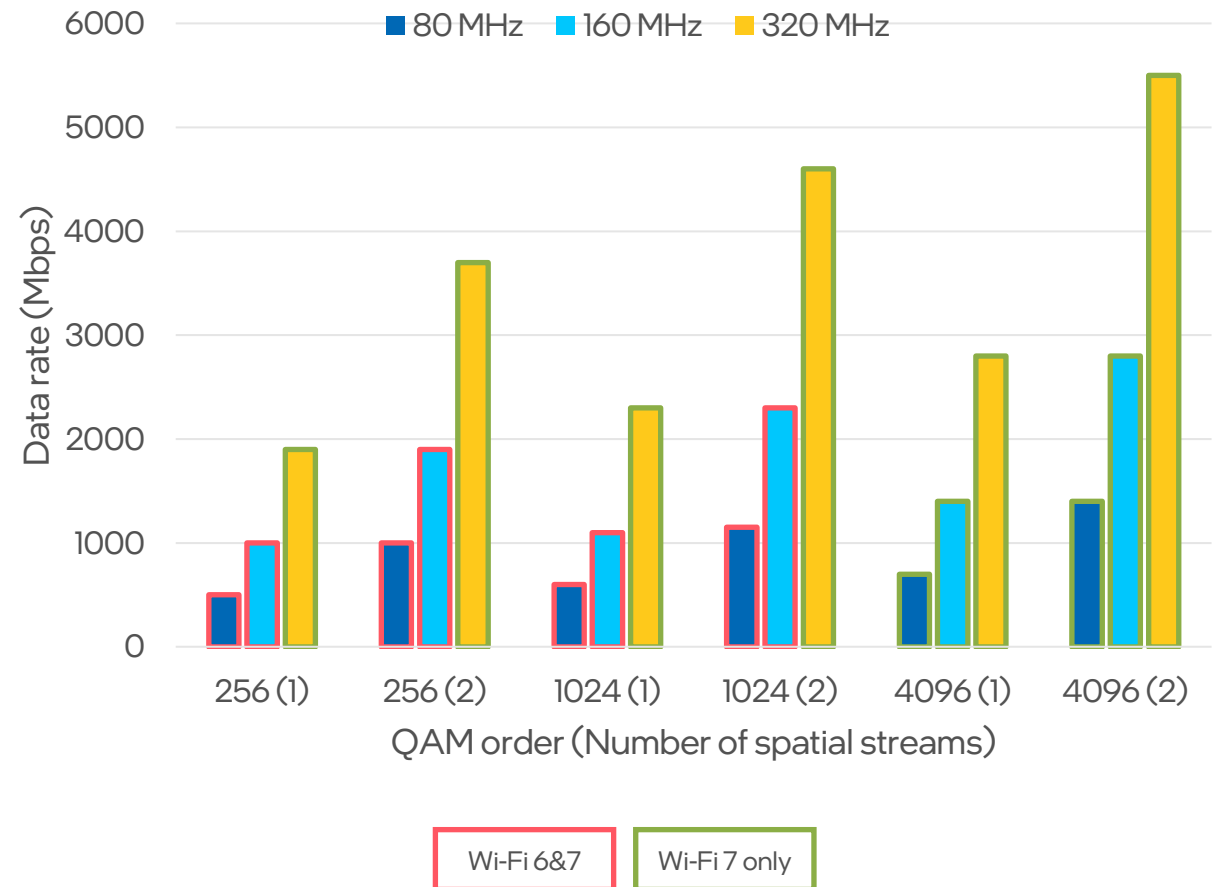

# Preamble Design

- Historically, the design of IEEE 802.11 preambles has only focused on backward compatibility.
  - Each Wi-Fi version includes a legacy non-HT SIGNAL (L-SIG) for coexistence.
  - Each Wi-Fi version introduces new auto-detection markers, which keeps complicating the auto-detection scheme.
- Wi-Fi 7 introduces a new universal SIGNAL field (U-SIG) to address the auto-detection and ensure forward compatibility.
  - U-SIG consists of version-independent fields, such as BW, UL/DL, TXOP duration, etc.
  - U-SIG consists of a PHY version identifier starting with EHT, which simplifies the autodetection.
  - U-SIG has the size of two symbols and will be consistent in location.

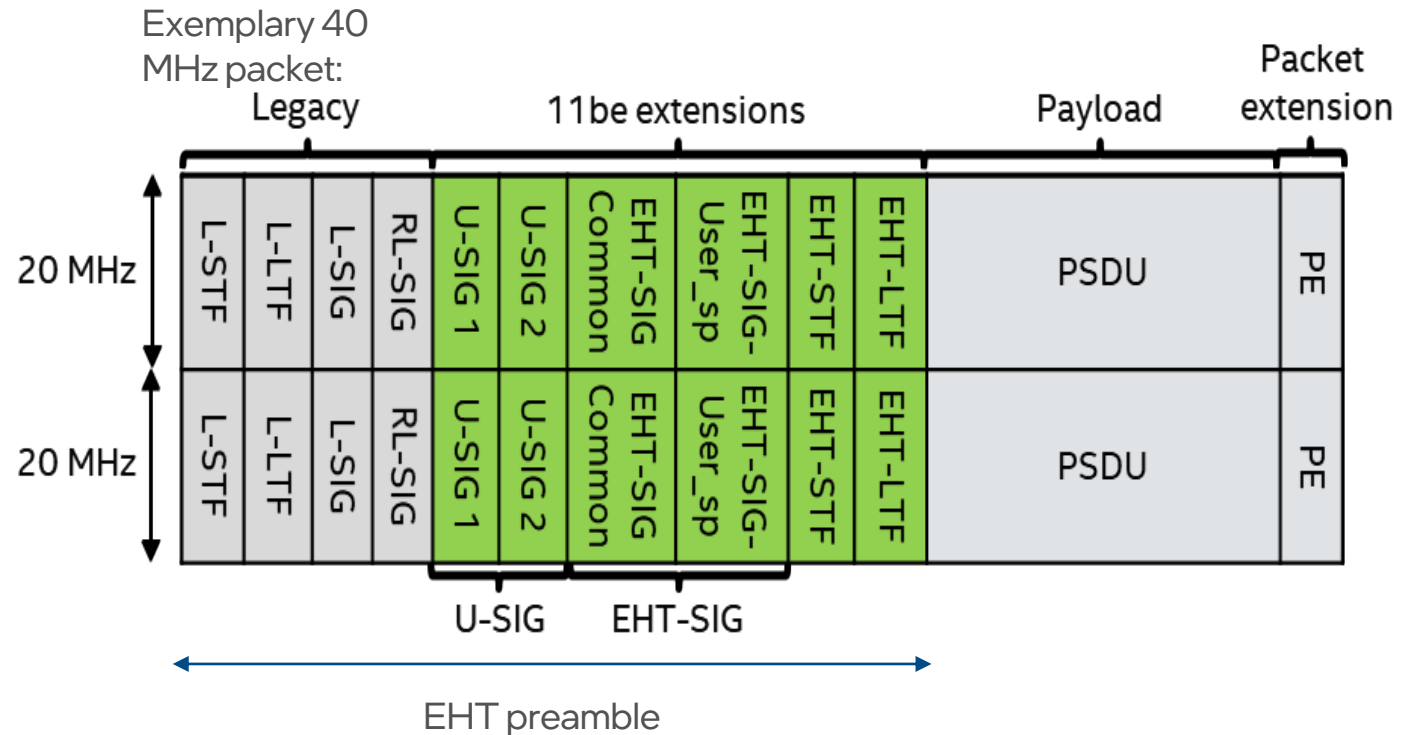

# 320 MHz Support

- Wi-Fi 7 supports up to 320 MHz bandwidth, as opposed to 160 MHz in Wi-Fi 6/6E.
  - Both 320 MHz and 160 + 160 MHz modes are supported.
  - Tone plan for 320 MHz uses duplicated 160 MHz tone plan based on Wi-Fi 6.

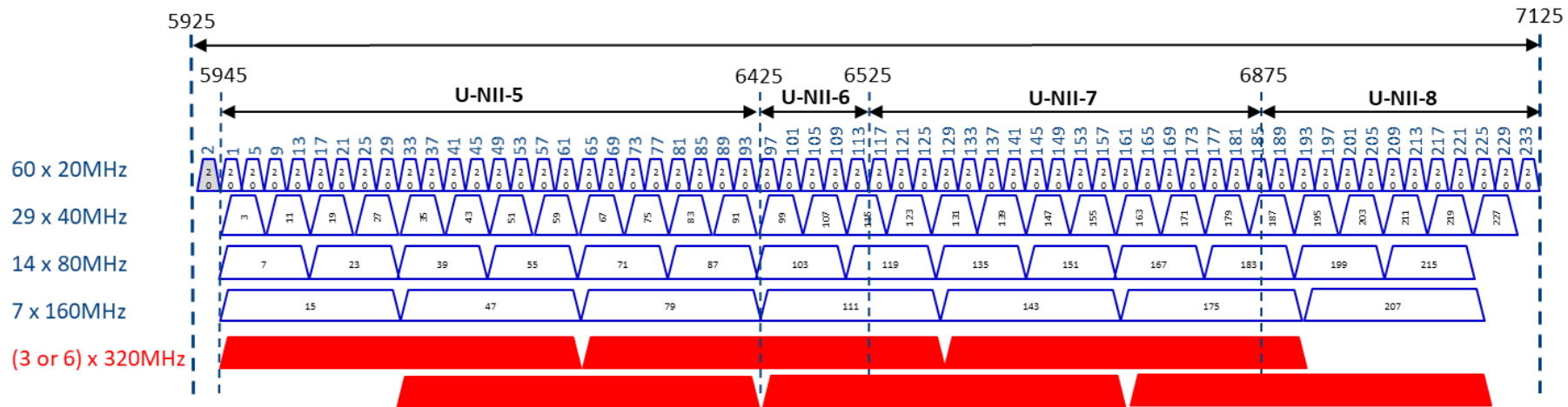



# 4096-QAM

- The highest-order modulation of Wi-Fi 6 is 1024-QAM, whereas Wi-Fi 7 supports 4096-QAM.
  - Beamforming is essential in making the use of 4096 QAM feasible.
  - MCS 12-13: two new MCS index corresponding to 4096-QAM.
  - Tx EVM requirement is -38db to achieve a good balance between Tx power and distortion.

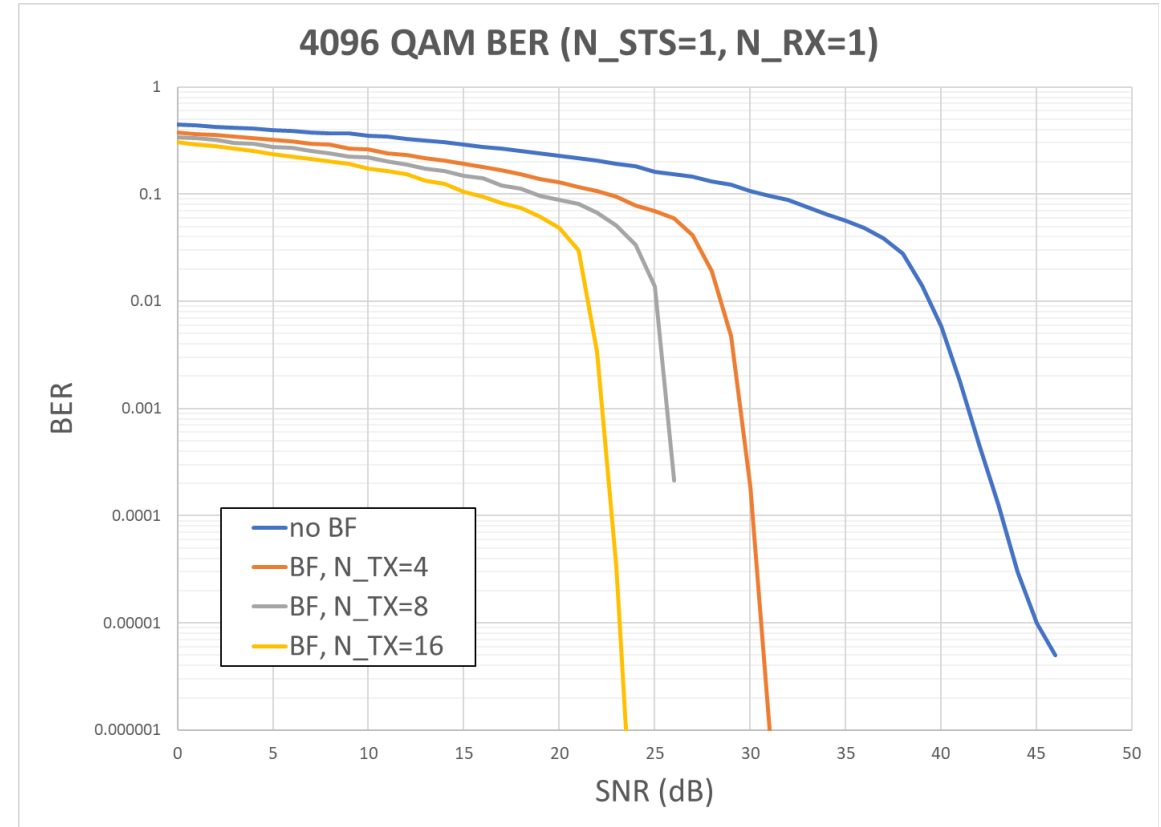

# Multi-RU Support

- Resource unit (RU): a group of subcarriers as an allocation for transmission.
- In Wi-Fi 6, each non-AP STA can only be assigned with a single RU.
- While this constraint simplifies the allocation scheme, it brings several limitations.
  - Degrades the spectral efficiency when number of users is small.
  - Wastes bandwidth in preamble puncturing scenarios, where the only primary 20 MHz can be used if radar detected in the secondary 20 MHz.
  - Fails to exploit the frequency diversity.
- Wi-Fi 7 introduces Multi-RU support by allowing the allocation of multiple RUs to a single STA.
  - Allowed Multi-RU combinations for different BWs are defined.

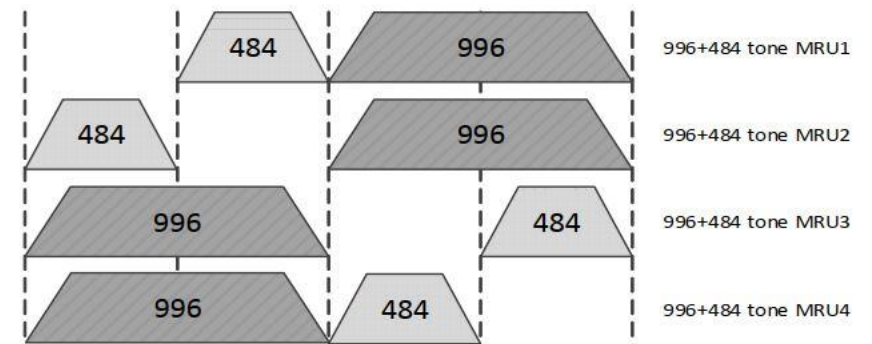

**Example: Allowed 996+484-tone MRUs in non-OFDMA 160 MHz EHT PPDU**

# Agenda

## Background and Introduction

### Recap of Wi-Fi 6/6E

- Technical Highlights
- Wi-Fi 6E: Wi-Fi in 6 GHz

## Introduction to Wi-Fi 7

### Wi-Fi 7 In-Depth Review

- Key PHY Enhancements
- Multi-link Operation
- Enhanced QoS Management

## Beyond Wi-Fi 7



# Multi-link Operation in Wi-Fi 7

- Existing Wi-Fi devices already support operating in different links.
  - A link is mapped to a specific channel in a specific band.
  - However, currently these links are operating independently without any coordination.
- Wi-Fi 7 introduces a unified framework to manage multiple links in a way that allows an optimized use of resources across multiple links.
  - **Throughput boost:** Aggregating multiple links achieves additive throughput for data flows split over links.
  - **Latency improvement:** Use of multiple links in parallel increases the chance of channel access, thus reducing latency.
  - **Increased reliability:** Duplicating critical data packets over multiple links significantly increases reliability.
  - **Traffic separation/differentiation:** Assigning data flows to different links based on the application needs achieves traffic separation and/or differentiation.

# Benefits of Multi-link Operation

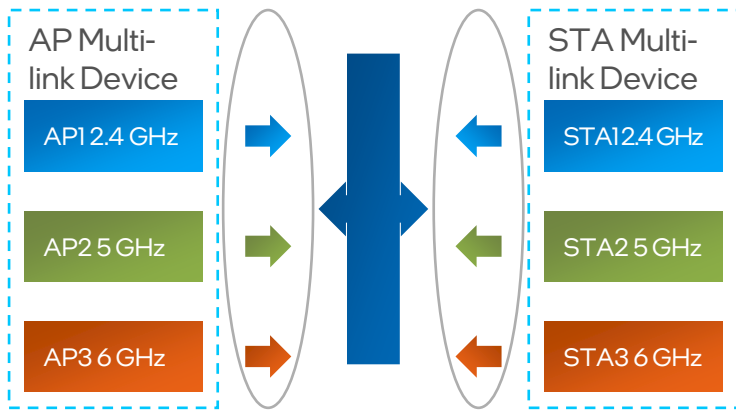

## Throughput boost

Aggregating multiple links for data transmission

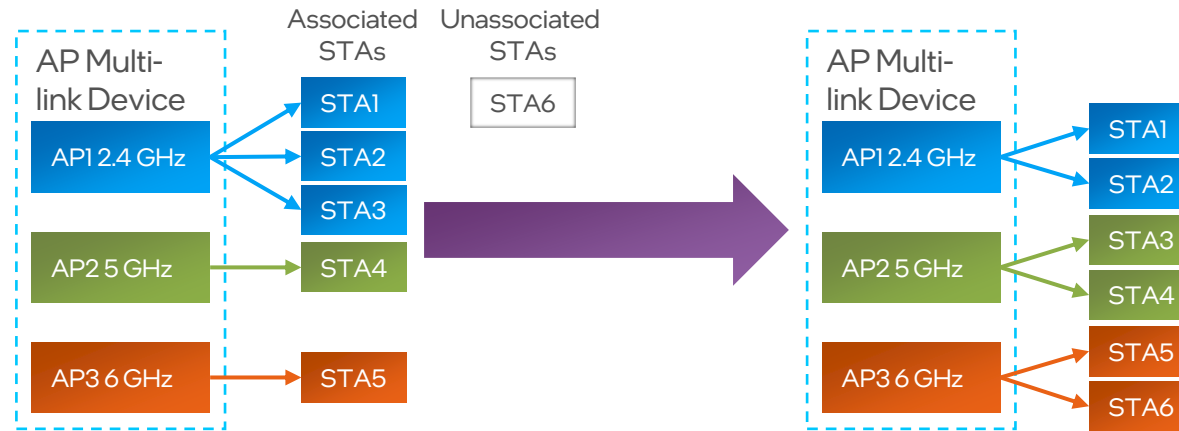

## Latency improvement

Load balancing to mitigate congestion on one link

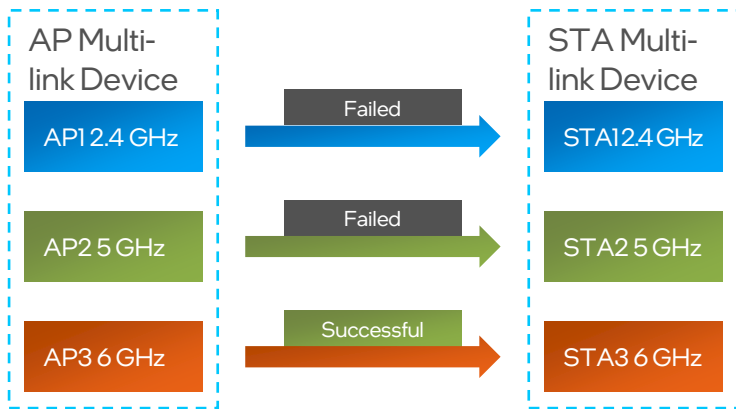

## Increased reliability

Duplicating critical packets on multiple links

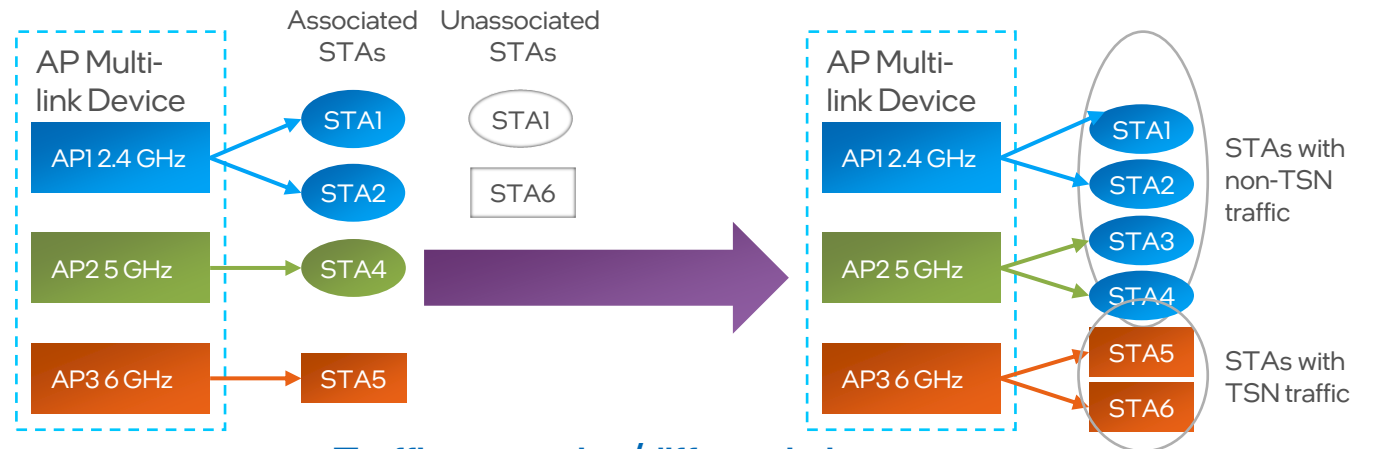

## Traffic separation/differentiation

Separating different traffic flows to different links

# Multi-link Framework

- Multi-link device (MLD): A device that is a logical entity and has more than one affiliated STA and has a single medium access control service access point to logical link control, which includes one MAC data service.
  - AP MLD: Every affiliated STA is an AP.
  - Non-AP MLD: Every affiliated STA is a non-AP STA.
  - An MLD does not necessarily have multiple radios.
    - Wi-Fi 7 supports the single link/radio non-AP MLD that supports operation on more than one link but receives or transmits frames only on one link at a time.

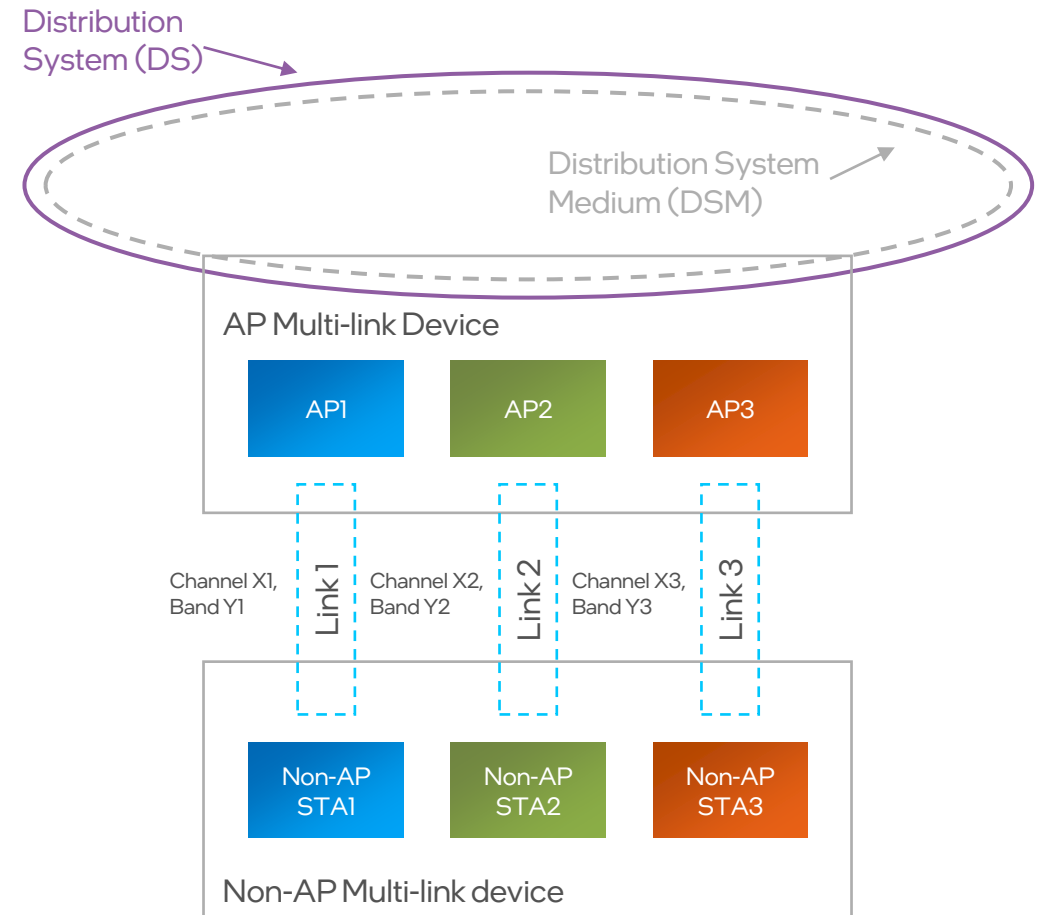

# Types of MLO

MLO Type	Number of Radios	Characteristics
Multi-link single radio (MLSR)	1	TX/RX over one link at a time.
Enhanced multi-link single radio (EMLSR)	1	MLSR with additional capability to listen to two links simultaneously.
Nonsimultaneous transmit and receive multi-link multi-radio (NSTR MLMR)	$\geq 2$	Simultaneous TX/TX, RX/RX over multiple links.
Simultaneous transmit and receive multi-link multi-radio (STR MLMR)	$\geq 2$	Simultaneous TX/TX, RX/RX, and TX/RX over multiple links.
Enhanced multi-link multi-radio (EMLMR)	$\geq 2$	MLMR with additional capability to dynamically reconfigure spatial multiplexing capability on each link.

Complexity & performance

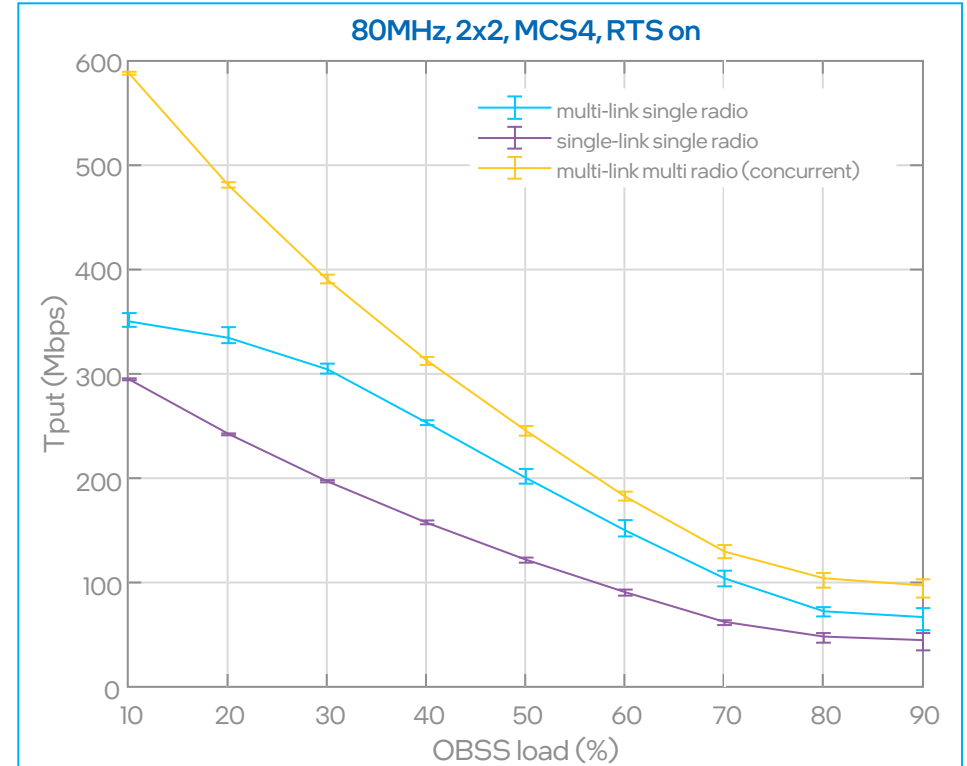

# Types of MLO: MLSR and EMLSR

- Enhanced MLSR operation
  - Single radio non-AP MLD listens to two or more channels simultaneously
    - Can therefore track the channel availability on two channels
  - 2x2 TX/RX module may be configured to 1x1 on each channel/band to listen to incoming packets on each channel
  - Data transmission happens on one link at a time
- Benefits
  - Can achieve most of benefits provided by dual-radio non-AP MLD on a single radio non-AP MLD.

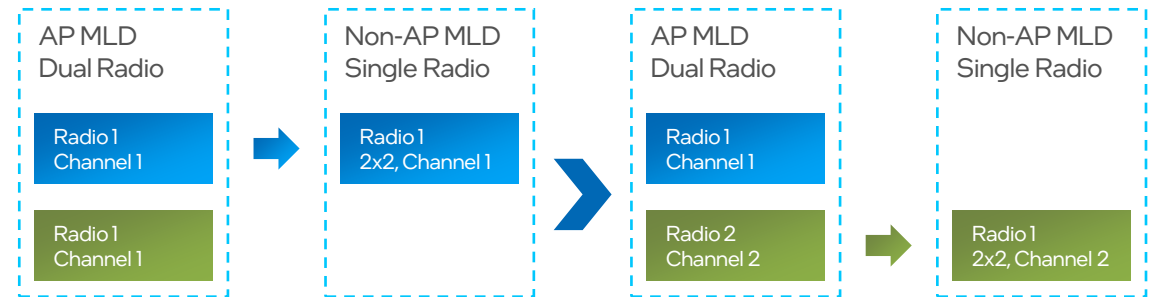

Multi-link Single Radio (MLSR) Operation

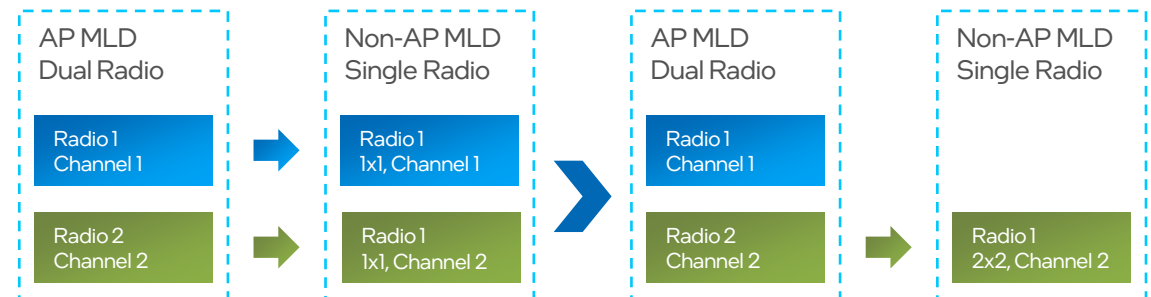

Enhanced Multi-link Single Radio (EMLSR) Operation



# Types of MLO: EMLMR

- Enhanced MLMR operation
  - Extends TX/RX chain switch across links for a single radio STA MLD to multi-radio STA MLD
  - R1 RX chains + T1 TX chains on link 1 and R2 RX chains + T2 TX chains on link 2
  - Is able to support (R1 + R2) RX chains and (T1 + T2) TX chains on either link 1 or link 2

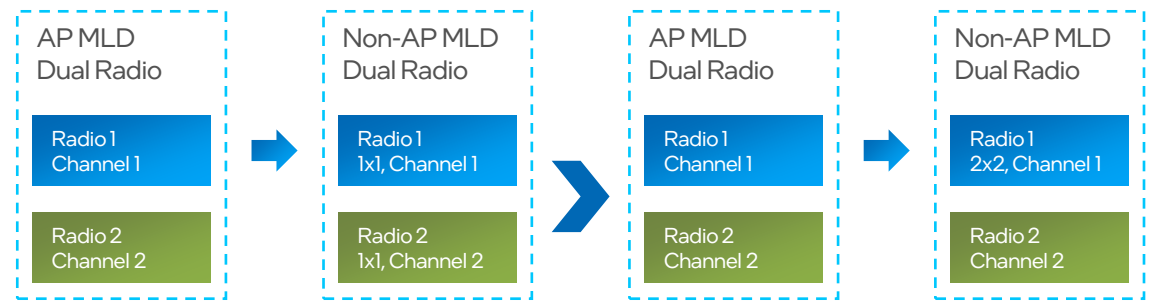

**RX chain switching for Enhanced Multi-link Multi-Radio (EMLMR) Operation**

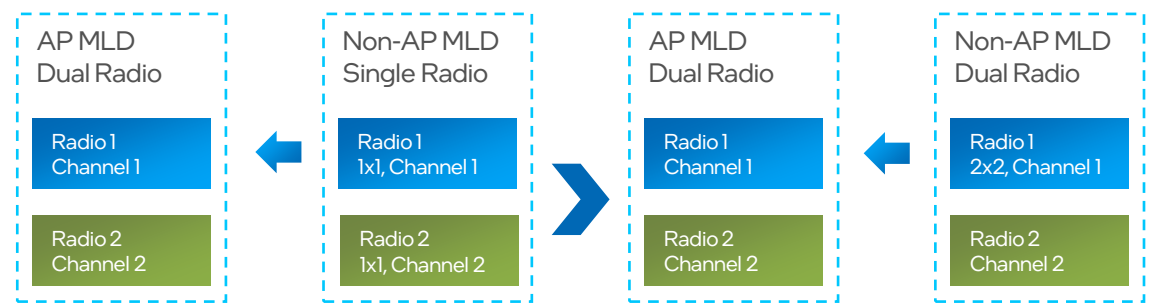

**TX chain switching for Enhanced Multi-link Multi-Radio (EMLMR) Operation**

# Types of MLO: NSTR MLMR and STR MLMR

- NSTR and STR MLMR
  - Due to in-device coexistence interference, simultaneous transmit and receive over multiple links may not always work.
    - For example, when an MLD transmits on 5 GHz band and receives on 6 GHz band in parallel.
  - In recognition of such constraints, NSTR and STR MLMR are defined.
  - Channel access schemes will be adapted based on NSTR or STR modes.

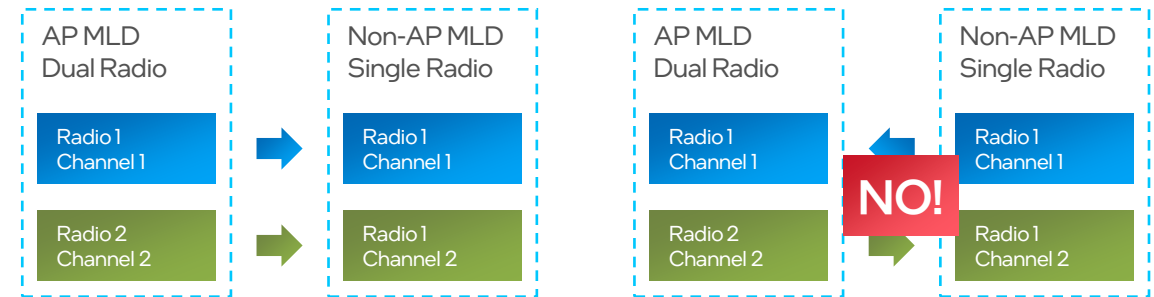

**Nonsimultaneous Multi-link Multi-Radio (NSTR MLMR) Operation**

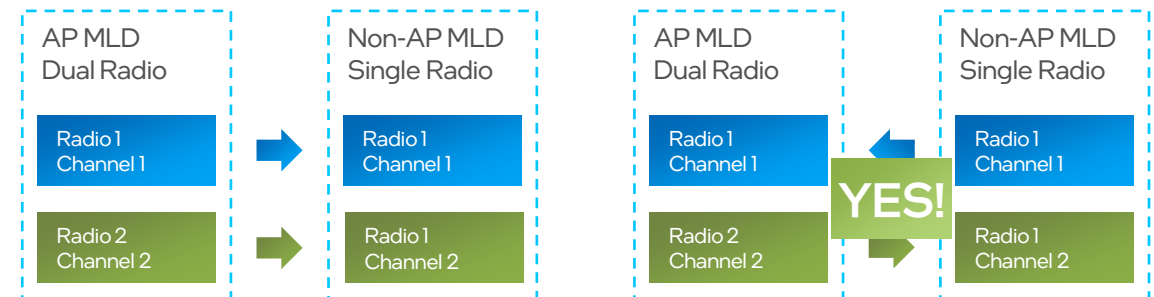

**Simultaneous Multi-link Multi-Radio (STR MLMR) Operation**

# Multi-link Discovery

- Discovery refers to the process where a non-AP STA discovers an AP in the environment and requests information from the AP to determine whether to associate with it.
  - Passive scanning: Listen for Beacon or unsolicited Probe Response
  - Active scanning: Transmit a Probe Request that solicits a Probe Response from an AP MLD.
- Multi-link discovery extends the process to MLD.
  - Difference is that now a non-AP MLD needs to obtain information corresponding to multiple APs in multiple links.
- With multiple links, a non-AP MLD can always perform passive or active scanning in each channel separately and obtain the needed information.
  - Time-consuming process to repeat scanning multiple times.
  - Several mechanisms are defined to simplify the process.

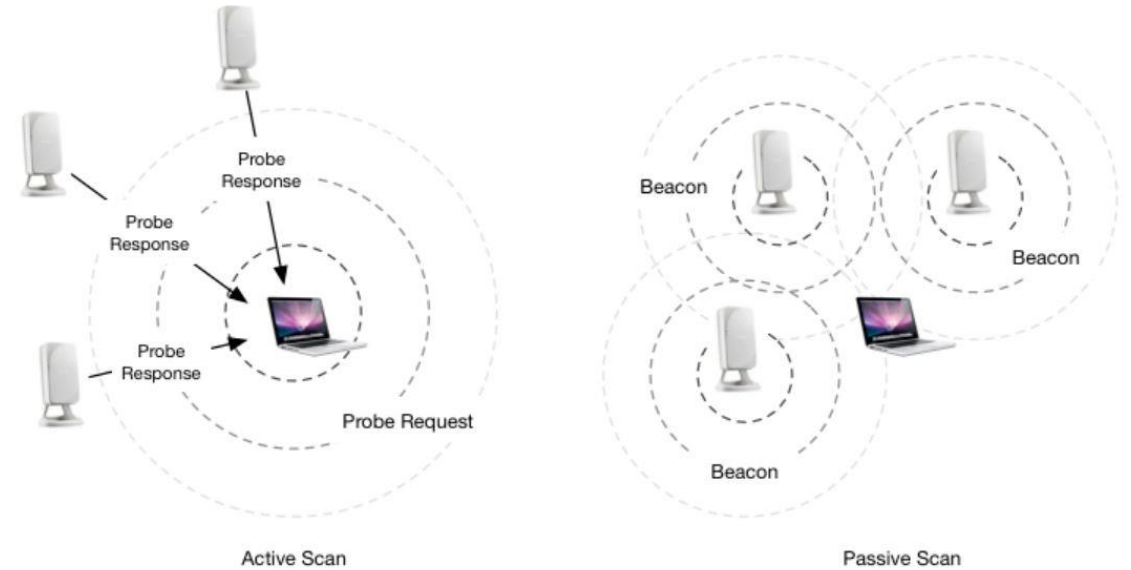
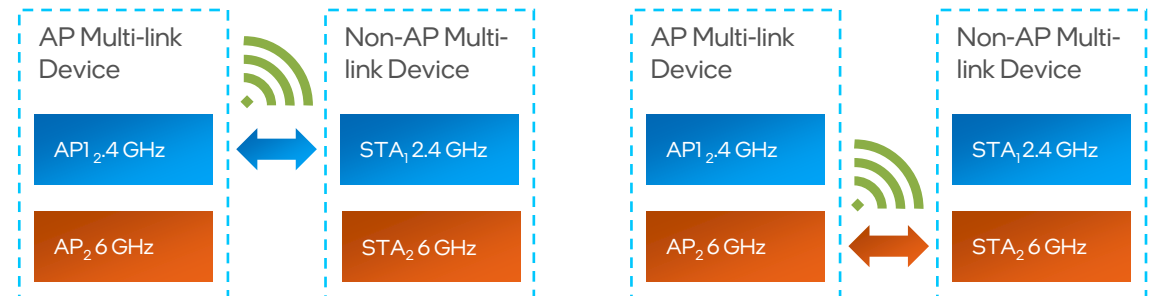

Figure source: <https://www.intuitibits.com/2017/08/11/understanding-scan-modes-wifiexplorerpro/>





# Basic Information vs. Complete Information

- Basic information: only a subset of most fundamental information that describes a reported AP in a specific link
  - E.g., Operating Class/Channel, BSSID, Short SSID, BSS parameters.
- Discovery for basic information of MLD
  - Each AP affiliated with an AP MLD includes a Reduced Neighbor Report (RNR) element in its transmitted Beacon or Probe Response frames, which consists of basic information of all other APs in the same AP MLD.
- Complete information: all the information elements and parameters related to a reported AP in a specific link
  - I.e., all the information that would be included in Beacon/Probe Response transmitted in that link.
- Discovery for complete information of MLD
  - A new variant Probe Request frame, ML Probe Request, is defined for a non-AP MLD to request the complete information of all APs in an AP MLD in one shot in one link.
  - Once received, any AP affiliated with an AP MLD responds with an ML Probe Response frame carrying a Multi-Link element, including complete information of all APs in an AP MLD

# Illustrations of MLD Discovery

Beacon or Probe Response transmitted by AP<sub>1</sub> in 2.4 GHz link

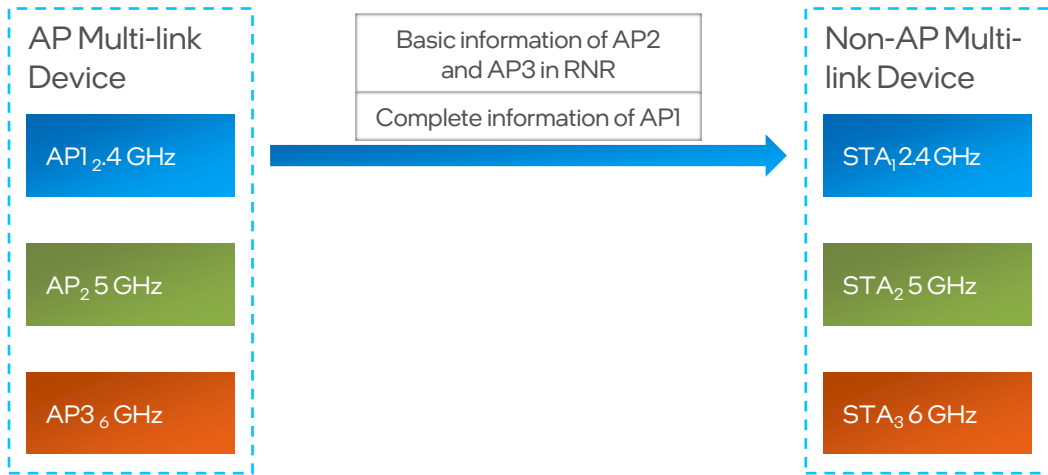

MLD Discovery---Basic Information

ML Probe Response transmitted by AP<sub>1</sub> in 2.4 GHz link

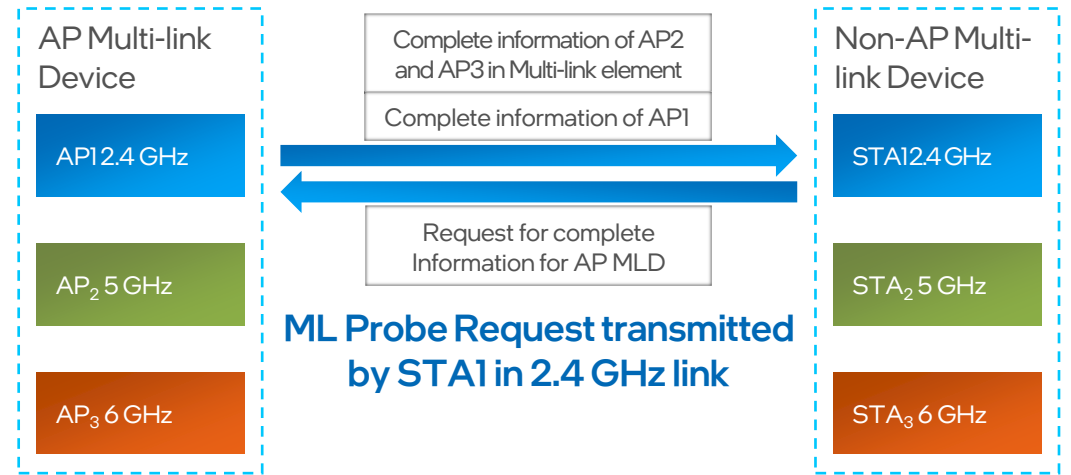

MLD Discovery---Complete Information

# Multi-link Setup

- After a non-AP MLD discovers an AP MLD, the next step is to perform association and authentication.
- Existing association process only allows to set up one link where association is done.
  - I.e., the setup of 3 links will require 3 associations.
- Multi-link setup is introduced to enable capabilities exchange and setup procedures for multiple links with only one execution in one link.
- Existing (Re)Association Request and (Re)Association Response frame are reused for Multi-link setup by including a new Multi-link element.
  - The Multi-link element includes a Common Info field that carries MLD level information common to all STAs, and one or more STA profile sub-element describing the complete information of each corresponding STA operating in one link.

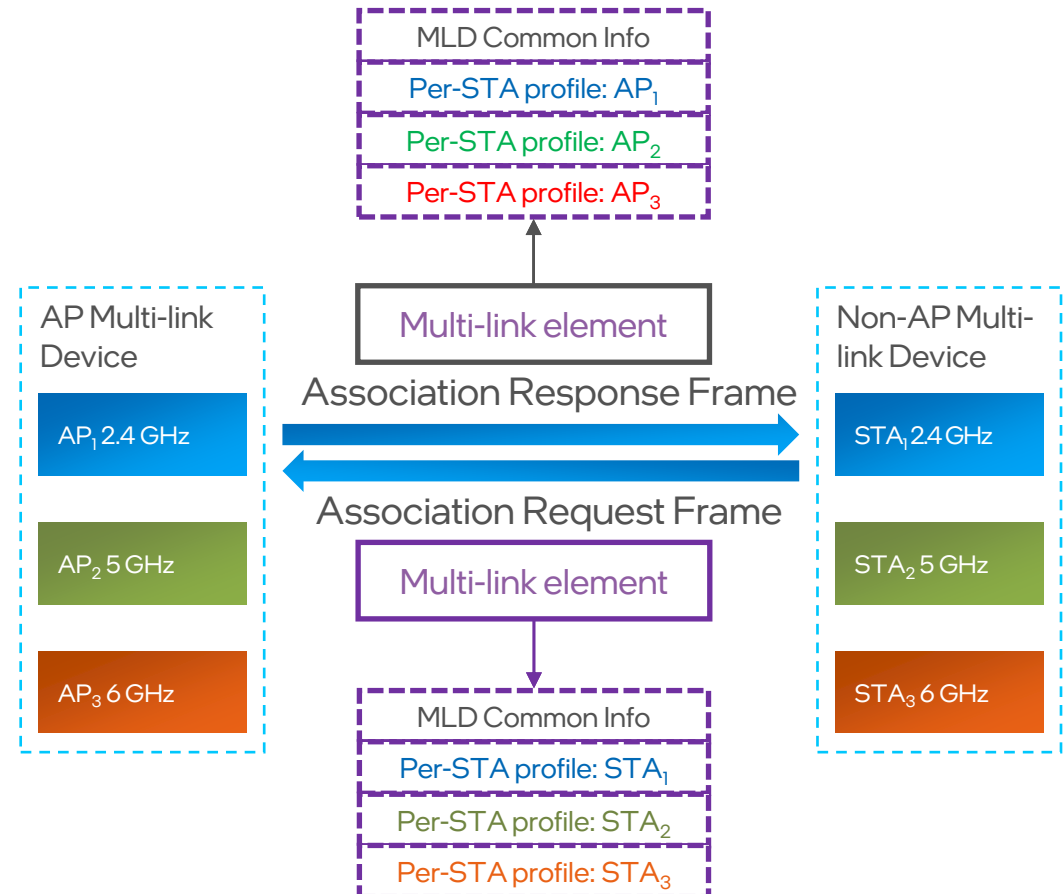

# Multi-link Security

- The 4-way handshake to establish pairwise and group keys is extended to cover Multi-link setup.
  - A pairwise master key (PMK) is established, and a pairwise transient key (PTK) is derived through a 4-way handshake between the non-AP MLD and the AP MLD.
  - The PMK, PTK, and the same packet number (PN) space are used for all the setup links for the pairwise transient key security association (PTKSA).
  - In contrast, different links use different group master key (GTK), integrity group temporal key (IGTK), and beacon integrity group temporal key (BIGTK) and each link has its own PN space.

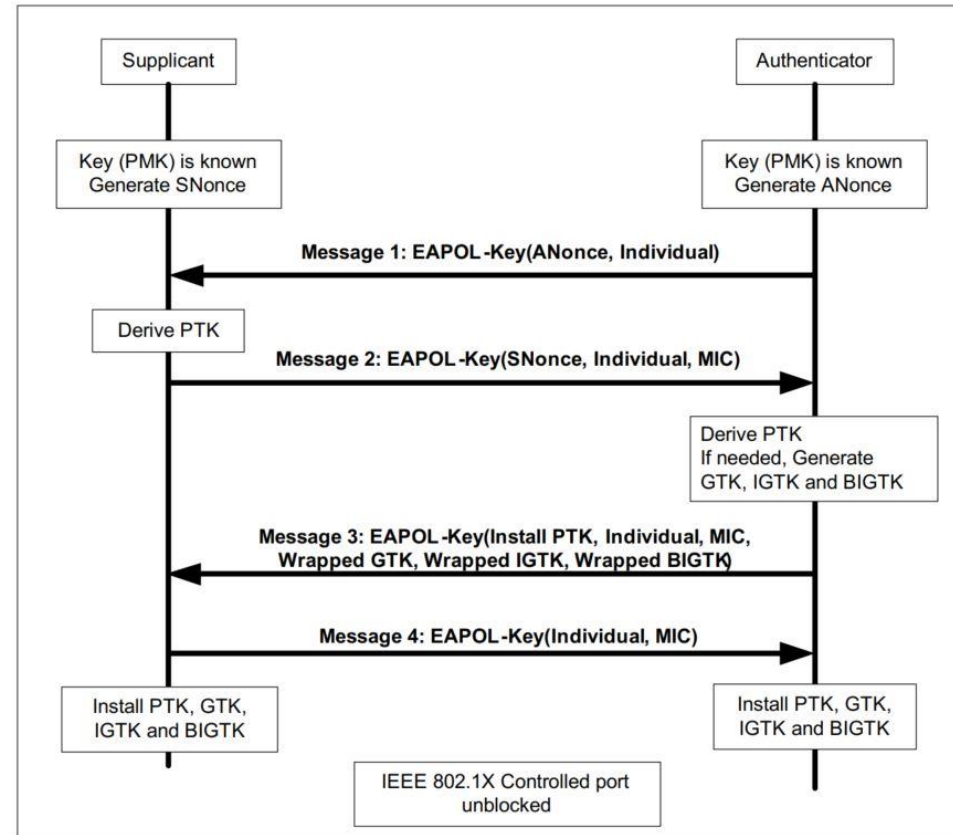

Establishing pairwise and group keys

# Multi-link Channel Access

**Fundamental rule: Independent channel access in each link.**

## EMLSR

- Frame (e.g., MU-RTS) is sent on one link to configure the antenna and activate the link where data communication will take place.

## STR

- No restrictions. Each link can transmit and receive independently irrespective of the operation in other links.

## NSTR:

- End PPDU alignment to avoid simultaneous TX/RX over a pair of links.

Multi-link channel access:  
**EMLSR operation**

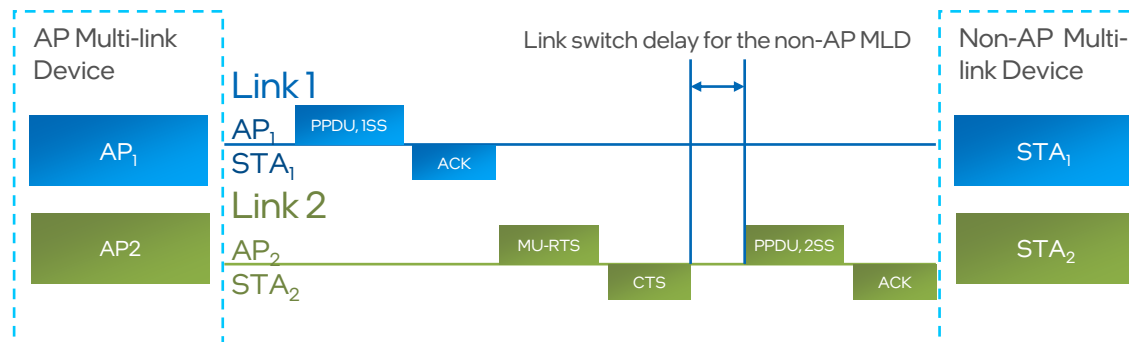

Multi-link channel access:  
**STR operation**

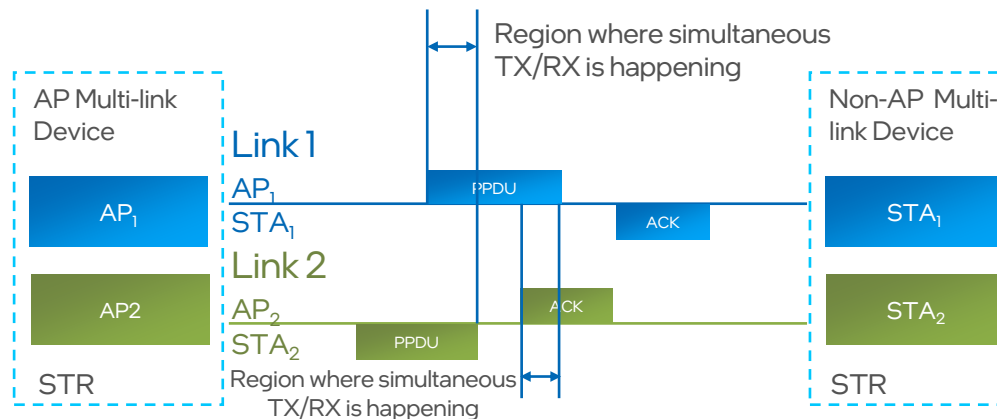

Multi-link channel access:  
**NSTR operation**

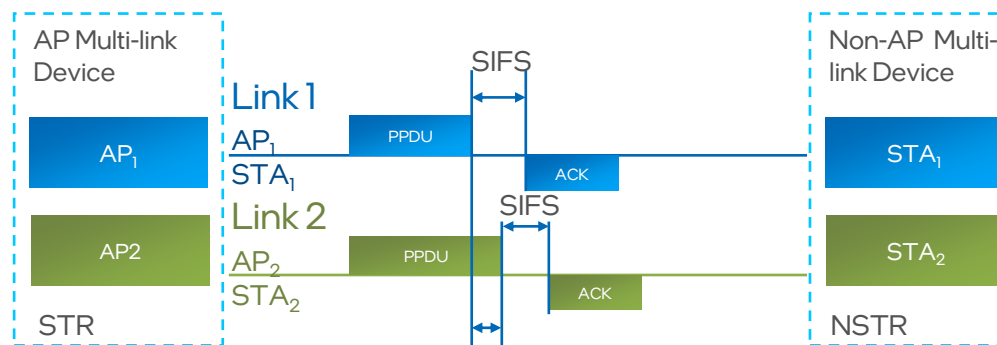

Difference of end times of simultaneously transmitted PPDUs needs to be within a threshold to avoid simultaneous TX/RX over two links



# Other Primary MLD Functions

- Block ack (BA) agreement and traffic indication
  - Legacy BA agreement is established on a single link.
  - MLD block ack agreement applies to all links.
  - Receive status of QoS Data frames may be signaled on other links.
  - Traffic indication map (TIM) element indicates buffered data for the whole MLD.

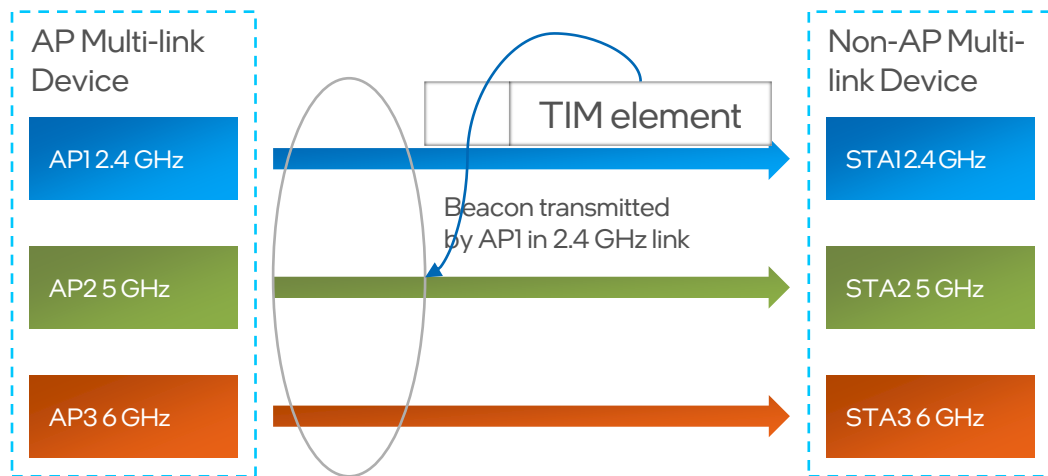

- TID-to-link mapping
  - Default mode: All TIDs are mapped to all links.
  - Optional mode: Map a subset of TIDs to a specific set of links.
    - Beneficial to achieve traffic separation and prioritization.
  - A link is enabled if at least one TID is mapped to it.

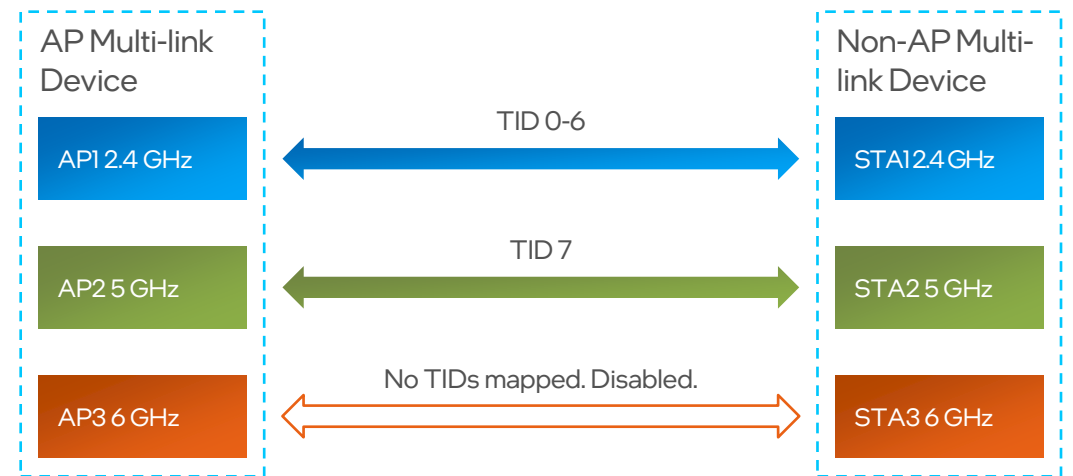

# Agenda

## Background and Introduction

## Recap of Wi-Fi 6/6E

- Technical Highlights
- Wi-Fi 6E: Wi-Fi in 6 GHz

## Introduction to Wi-Fi 7

## Wi-Fi 7 In-Depth Review

- Key PHY Enhancements
- Multi-link Operation
- Enhanced QoS Management

## Beyond Wi-Fi 7

# Enhanced QoS Management

- **Wi-Fi 6 can achieve single-digit millisecond** latency, but the worst-case latency can be high in congested environments.
- With the introduction of features like multi-link operation and 320 MHz channels in Wi-Fi 7, latency will be reduced even further.
- However, to provide enhanced QoS management, for example, deterministic low latency required by some usages (e.g., industrial IoT, AR/VR), new schemes need to be defined.

## Wi-Fi 7 features for QoS enhancement

- Define QoS provisioning model with dedicated, deterministic, low-latency (LL) and reliable access category
- Enhanced channel access
  - Restricted service periods
  - National security and emergency preparedness (NSEP) priority service
  - Triggered peer-to-peer transmission

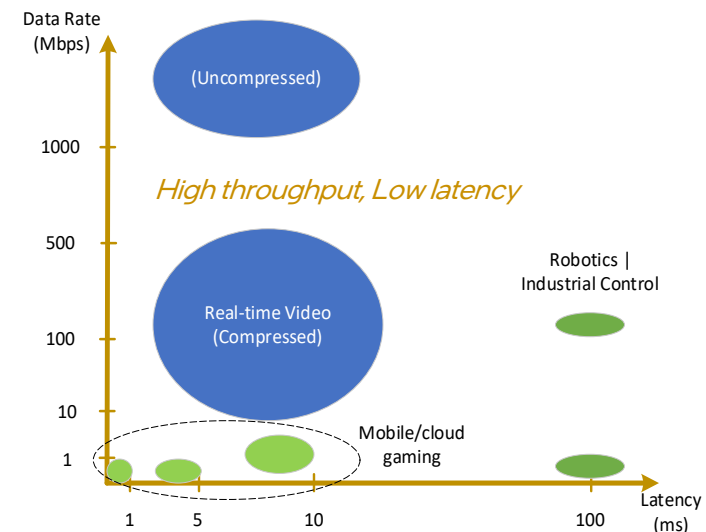

# Framework for Enhanced QoS Management

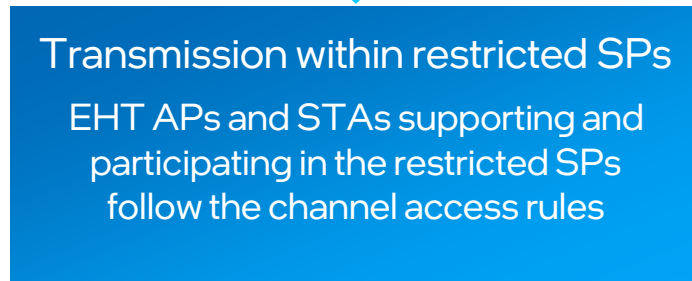
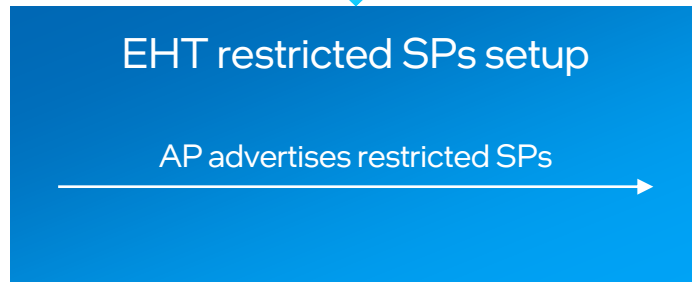

## Traffic requirements:

SI= 10 msec  
Latency bound = 2 msec  
PDR = 99.9%

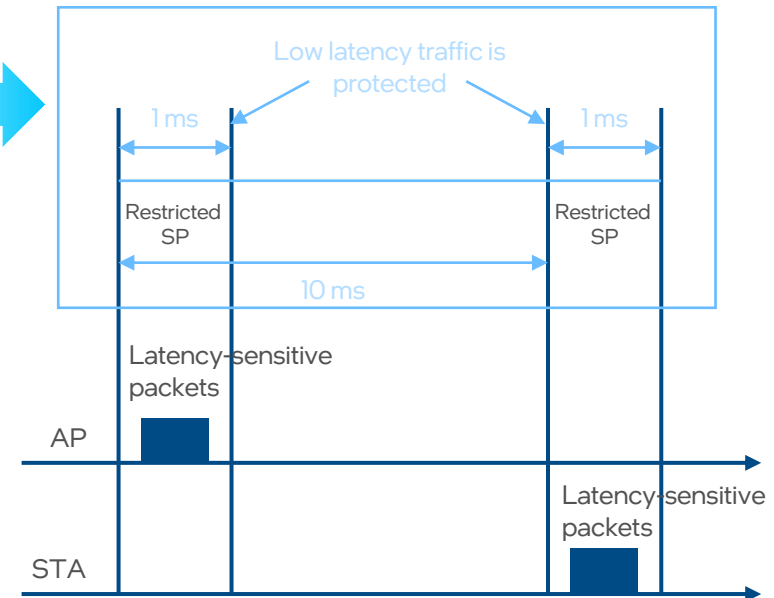

# QoS Signaling

- In order to serve and prioritize QoS traffic, the first step is to identify and signal the traffic characteristics.
  - Used to differentiate low latency traffic from regular traffic.
  - Providing traffic pattern and QoS requirements to request corresponding service.
- Wi-Fi 7 will define a new information element to carry relevant parameters and a protocol at the MLD level to enable QoS signaling.

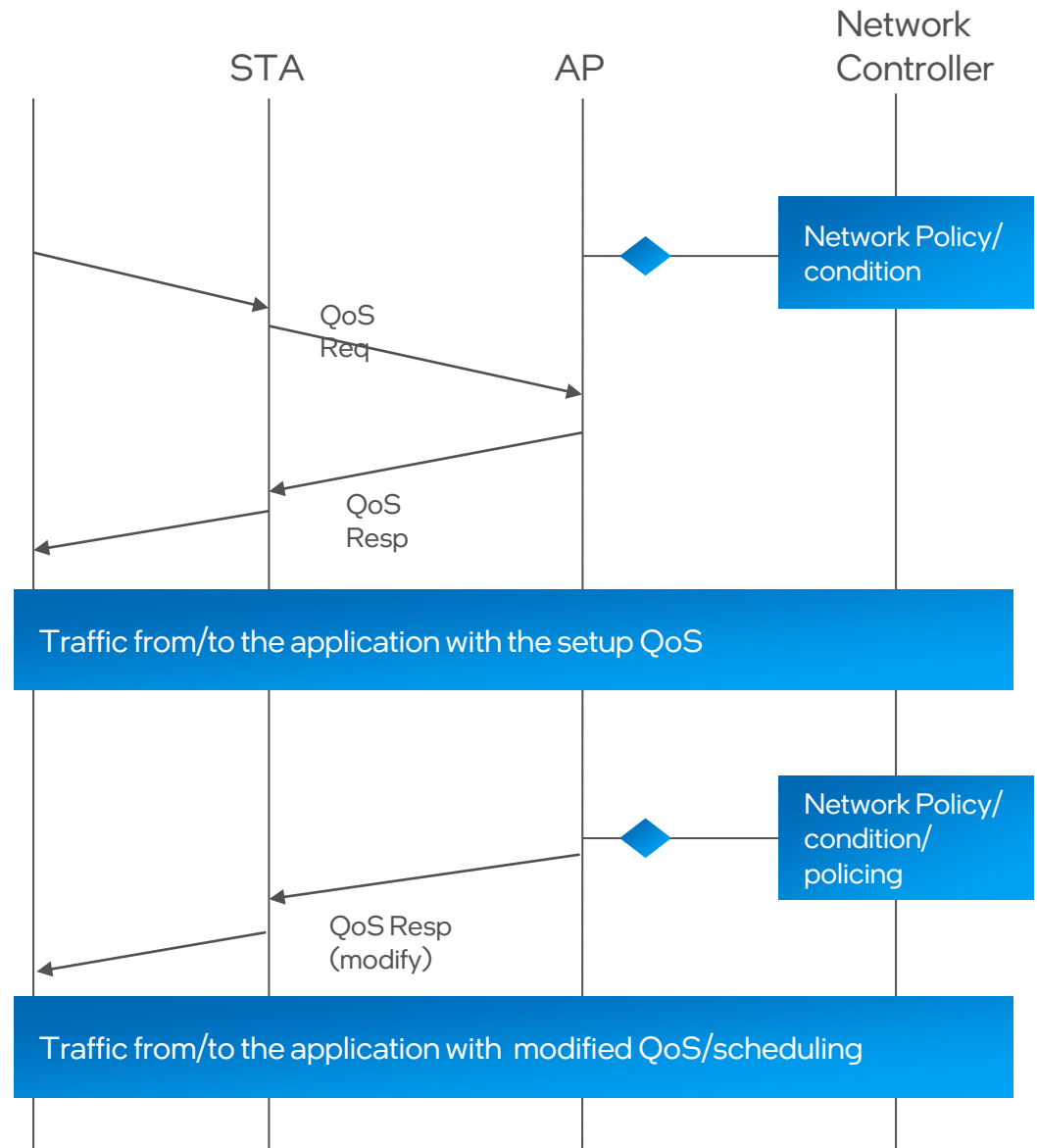

# Restricted Service Periods

- Wi-Fi 7 introduces restricted service periods (SPs) such that:
  - Any EHT non-AP STA that supports this feature shall end its TXOP before the start of the restricted SPs.
  - An EHT AP may announce quiet intervals during which non-AP STAs shall not access the medium.
  - EHT non-AP STAs that are members of restricted SPs are allowed to ignore the quiet intervals if they overlap with the restricted SP.

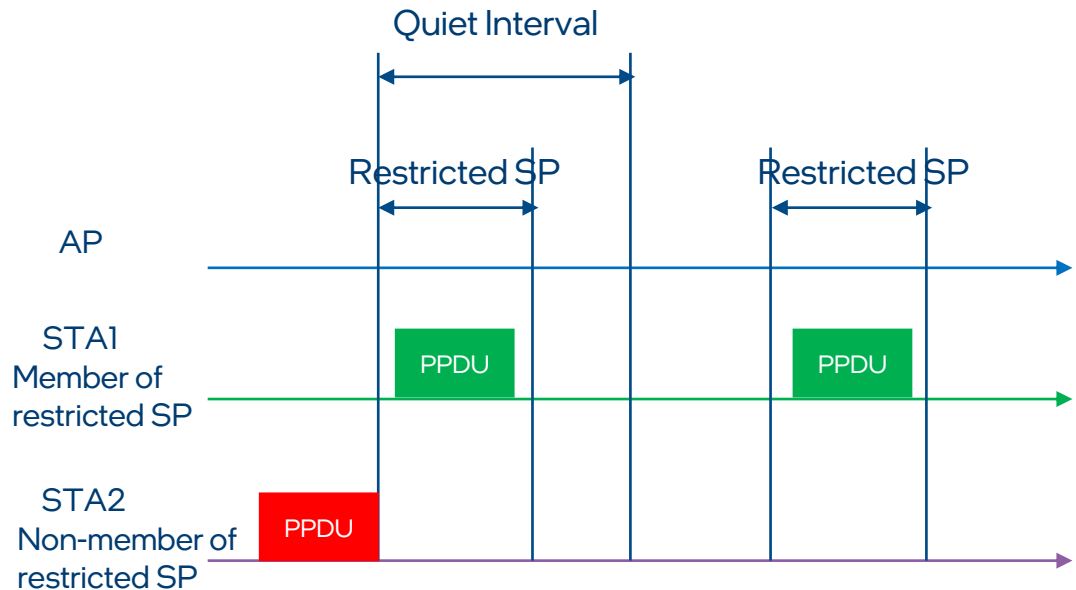

# NSEP Priority Service

- The motivation is to provide prioritized access to system resources for authorized users for NSEP priority services in WLAN networks.
  - E.g., General emergency/disaster event, pandemic event, NSEP from IoT devices
- AP and non-AP STA exchange capabilities and verify the authority of non-AP STAs to use NSEP priority access.
- NSEP priority access operates in an on-demand fashion.
  - NSEP priority access is invoked by either a solicited request from the non-AP STA or an unsolicited request from the AP.

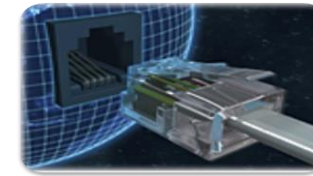

NS/EP Priority Service invoked

WPS/NGN Priority Service

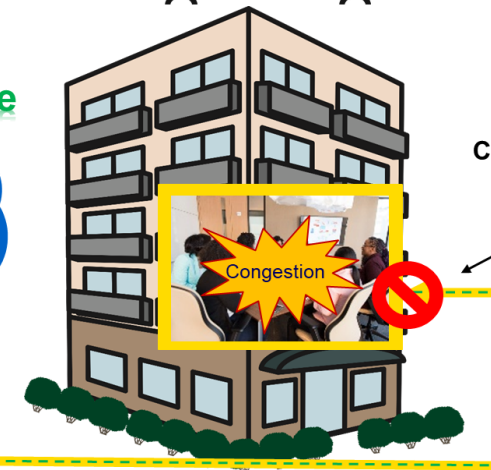
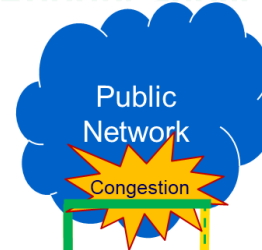
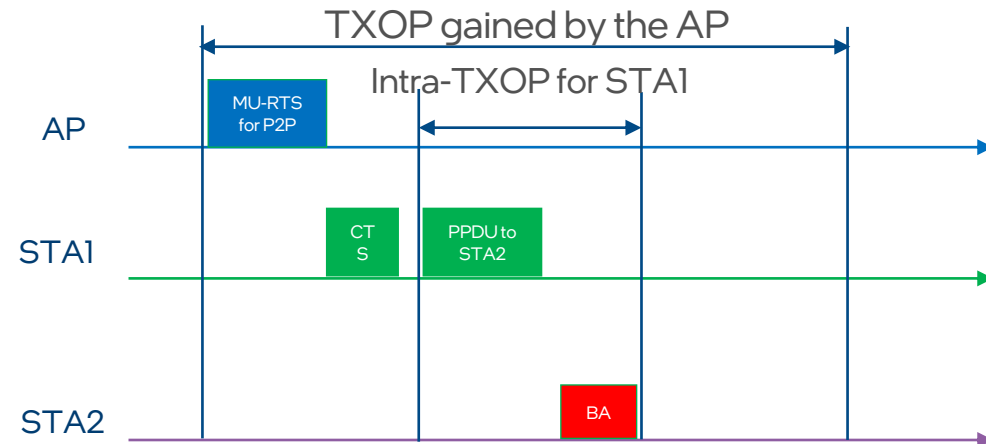

Figure source: 11-19-1901-04-00be-priority-access-support-in-ieee-802-11be-what-and-why

# Triggered Peer-to-Peer (P2P) Transmission

- Enable direct link transmission between two non-AP STAs scheduled by the AP
- Example use cases
  - Miracast streaming from laptop to monitor
  - VR applications
  - Wireless file transfer from phone to printer
- AP transmits an MU-RTS Trigger frame and allocates a time duration for P2P transmission





# Agenda

## Background and Introduction

### Recap of Wi-Fi 6/6E

- Technical Highlights
- Wi-Fi 6E: Wi-Fi in 6 GHz

### Introduction to Wi-Fi 7

### Wi-Fi 7 In-Depth Review

- Key PHY Enhancements
- Multi-link Operation
- Enhanced QoS Management

### Beyond Wi-Fi 7

# Multi-AP Coordination: Motivation

- Existing Wi-Fi technologies have been largely focusing on fully distributed operations among different APs without sophisticated coordination.
- Proprietary mesh Wi-Fi systems are already well accepted in the market.
  - However, most of these solutions are mainly optimizing long-term network configurations, including channel selection, load balancing, network security, etc.
- It is desirable to achieve tighter optimization in the PHY and MAC layer to enhance the performance of Multi-AP systems in various aspects.
- Diversified flavors of Multi-AP techniques can improve the network performance in multiple aspects.

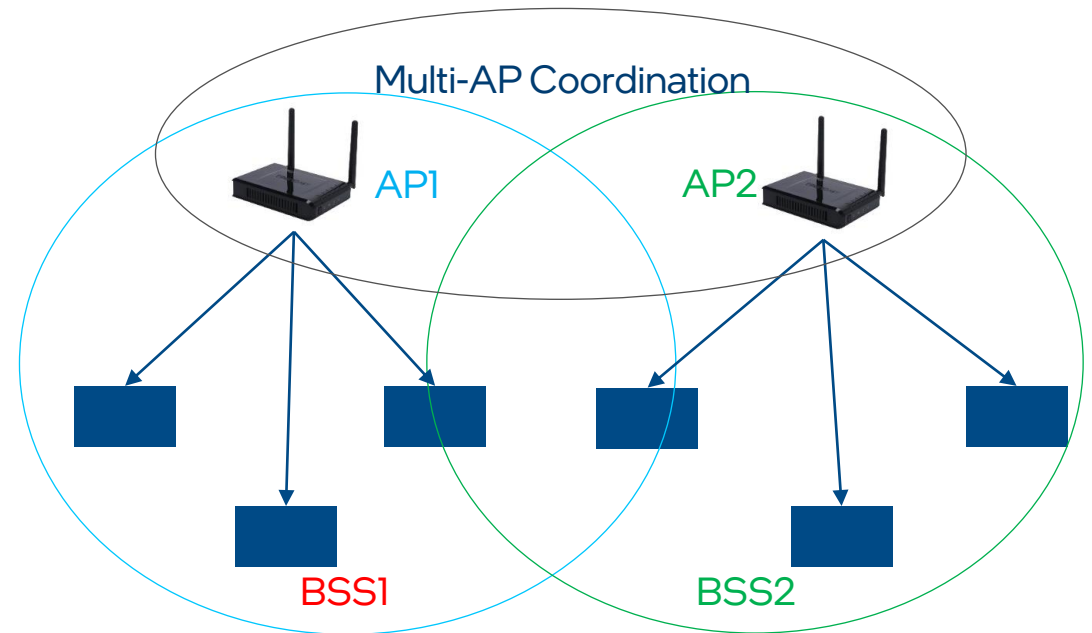

# Multi-AP Framework

- There is a unified framework to accommodate different flavors of multi-AP coordination, which consists of the following:
  - AP candidate set: a set of APs that can initiate or participate in Multi-AP coordination.
    - Defines the trusted region of Multi-AP coordination in the management domain.
    - Only APs within the same AP candidate set are allowed to perform Multi-AP coordination with each other.
    - The formation of AP candidate set is implementation specific.
  - Sharing AP: The AP that obtains a TXOP and initiates a specific type of Multi-AP coordination in its owned TXOP.
  - Shared AP: The AP that is coordinated for the Multi-AP transmission by the Sharing AP.
    - There may be multiple Shared APs in one coordinated TXOP.

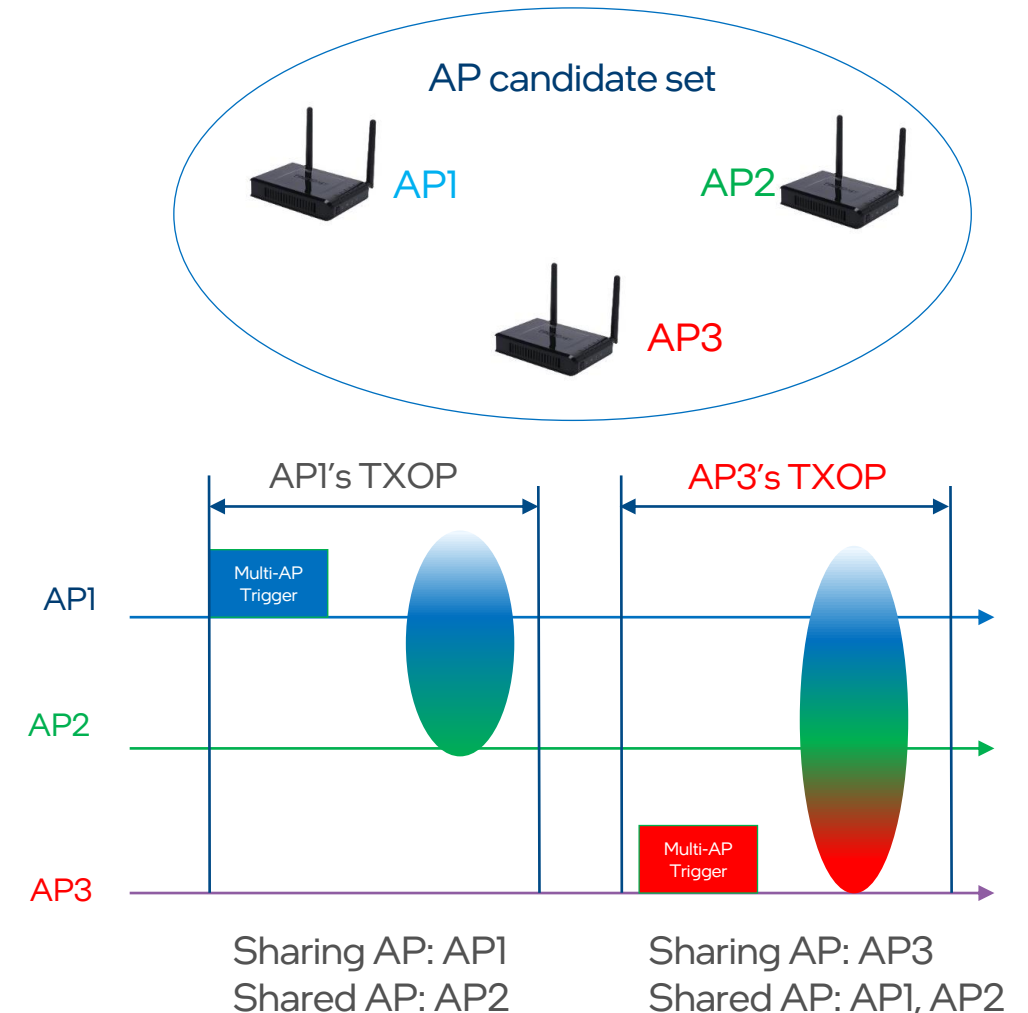

# Modes of Multi-AP Coordination (1/2)

- Different flavors of multi-AP solutions are being considered

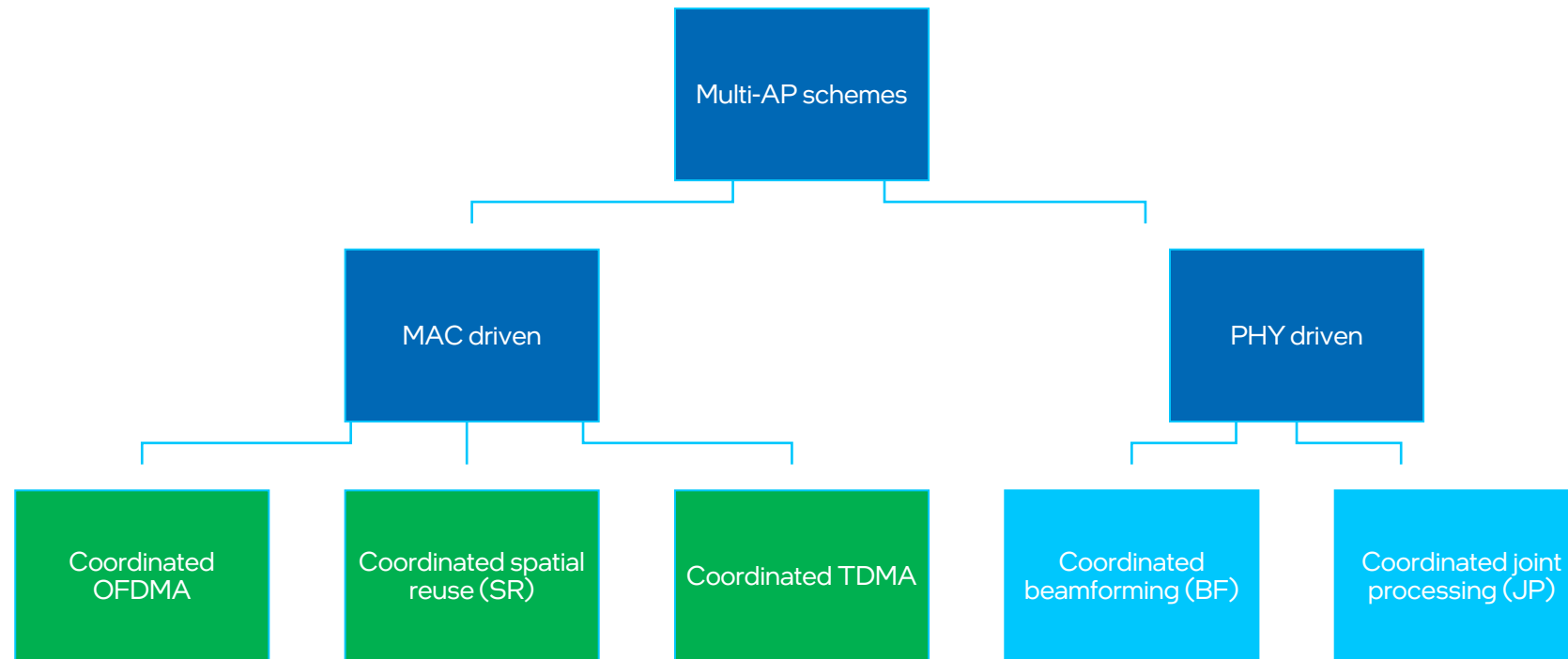

# Modes of Multi-AP Coordination (2/2)

MAC-driven Multi-AP modes

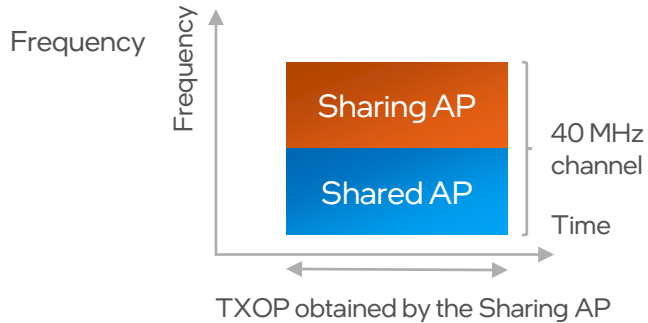

**Coordinated OFDMA**  
The Sharing AP and Shared AP(s) transmit simultaneously during the same time period, but on different 20 MHz channels.

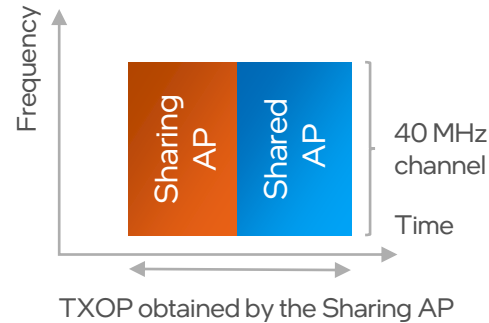

**Coordinated TDMA**  
The Sharing AP and Shared AP(s) transmit simultaneously on the same channel, but during different time periods.

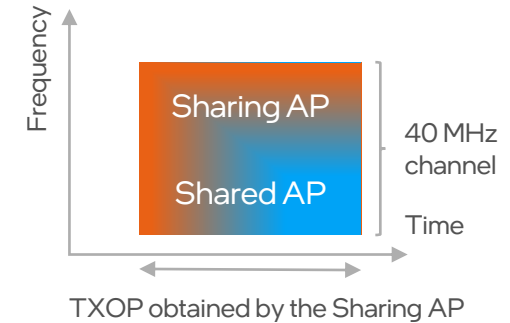

**Coordinated Spatial Reuse**  
The Sharing AP and Shared AP(s) transmit simultaneously on the same channel, but during the same time periods.

PHY-driven Multi-AP modes

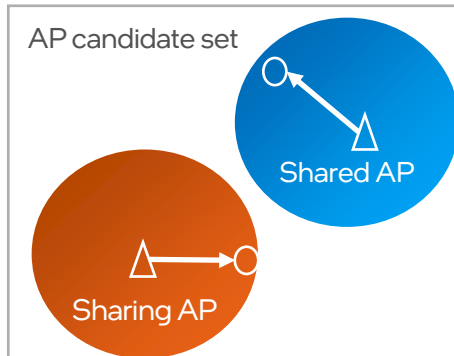

**Coordinated Beamforming**  
A sharing AP sound channels from their own STAs and from STAs associated with other Shared AP(s) so that it can null the interference caused towards the Shared AP's transmission.

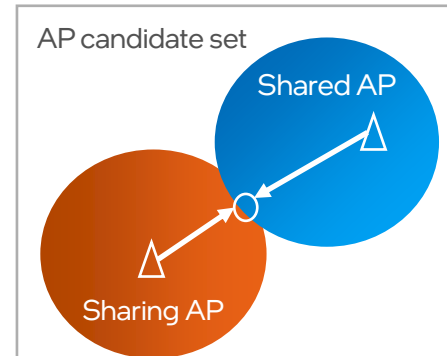

**Joint Processing**  
The Sharing AP and Shared AP(s) jointly transmit to the same STA.

# OpenRoaming: Anywhere & Any Network Connected Wi-Fi Clients

## Problem Statement

Wi-Fi hotspots can be found virtually everywhere, but clients connecting to these hotspots are either disallowed (e.g., lack of credentials) or cumbersome (e.g., captive portal).

## Solution

OpenRoaming (OR) is an industry initiative that aims at connecting clients to Wi-Fi networks as seamlessly and pervasively as in cellular.

- Based on Passpoint technology
- Scalable, many-to-many business relationships

## OpenRoaming Players

### Ecosystem Brokers

- Infra vendors
- Cert. authorities



### Identity Providers



### Network Providers

- Any Wi-Fi network
- Monetization: soft portal, business deal with ID provider, etc.



### End-Users/Devices

- Phones, PCs, IoT, etc.
- Broad OS support

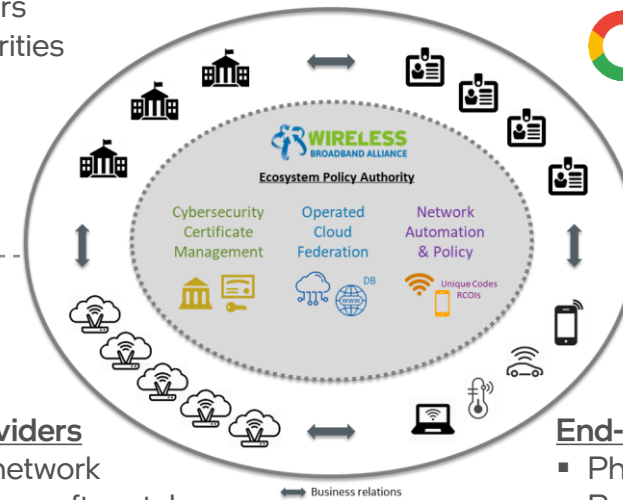

OpenRoaming enables seamless connectivity of Wi-Fi clients across networks

# Wi-Fi Sensing

- Wi-Fi sensing exploits channel changes measured by amplitude and phase.
  - Channel varies as changes in the environment alter the paths.
  - ML/signal processing can infer the cause (e.g., human presence, activity).
  - Single device or multi-device sensing possible.
- IEEE 802.11 established a new task group IEEE 802.11bf on Wi-Fi sensing.
- Applies to 2.4/5/6/60 GHz.

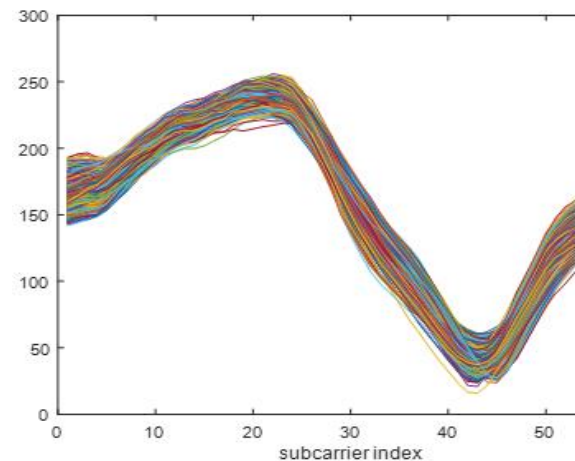
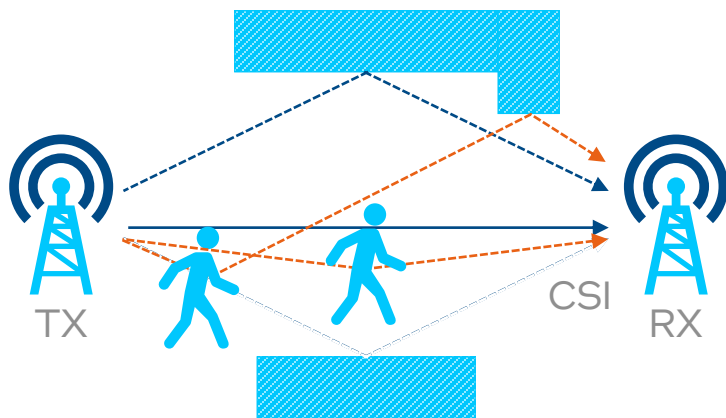

**Amplitude, static environment (no motion)**

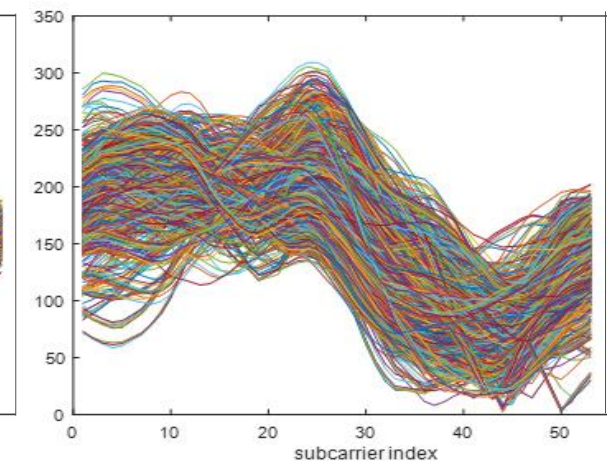

**Amplitude, dynamic environment (motion)**

# Applications of Wi-Fi Sensing

## Enterprise



Security, environment control



Wake on approach, walk away lock



Conference room occupancy



Gesture control

## Residential



Security, environment control



Elderly monitoring



Baby monitoring



Gesture control

## Retail and Hospitality



Environment control, Smart housekeeping



Signage efficiency



Gesture control

## Capabilities

Motion detection

Proximity detection

People counting

Human activity recognition

Vital signs detection



# Deterministic Operation Will Expand Wi-Fi to New Applications

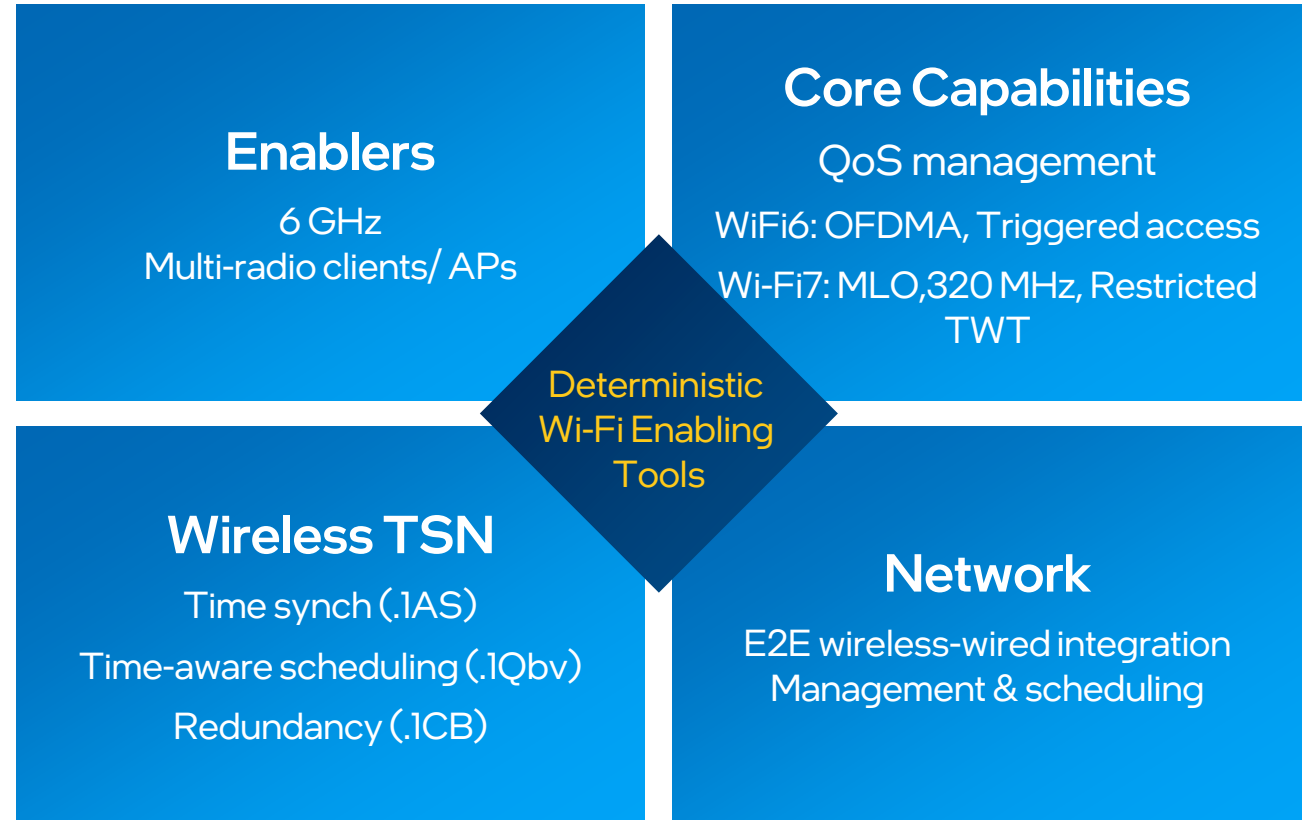
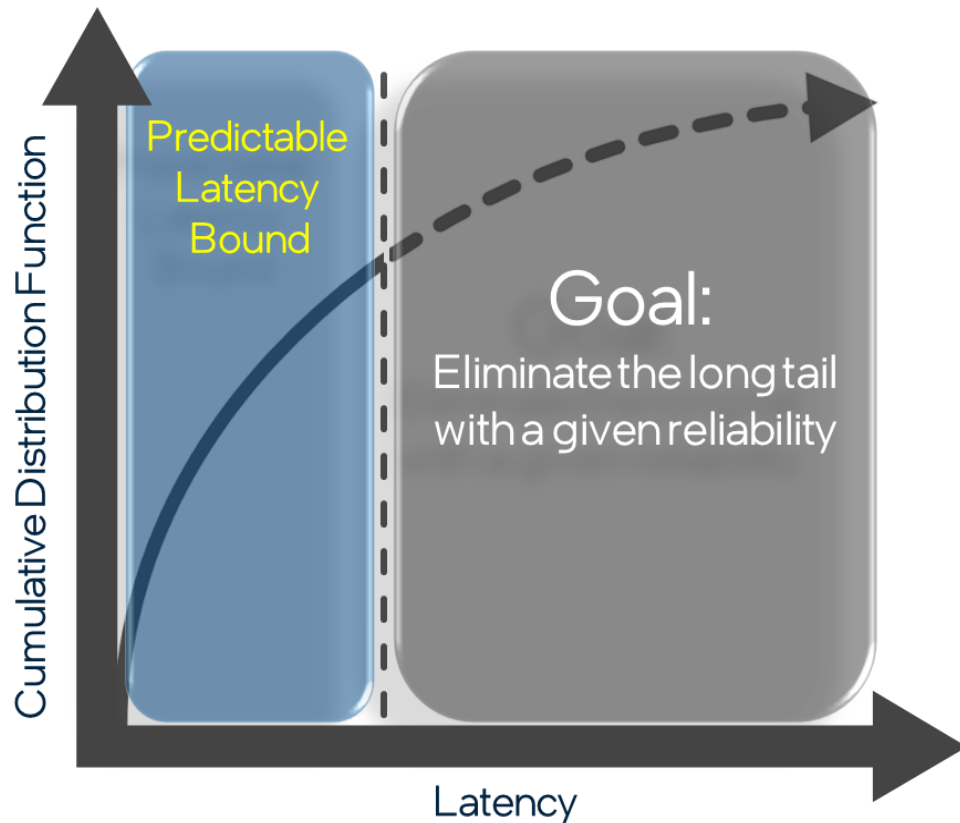

# Expanded Peer-to-Peer Experiences & Technologies

## Device Sharing Experiences

Resources (e.g., compute, screen, hotspot),  
Data, notifications, etc...

Display Expansion  
(Wireless display connection)

Inking / Stylus  
(Companion inking device)



Camera  
(Multi-camera / platform)

PC – Phone Collaboration  
(Seamless, cross-device app usage)

## Wireless Capabilities Required

Secure pairing, Low-latency,  
Dual / Concurrent connectivity,  
Ranging, and others...

# 6 GHz AFC (Automated Frequency Coordination) Enables Outdoor & Improved Indoor Connectivity

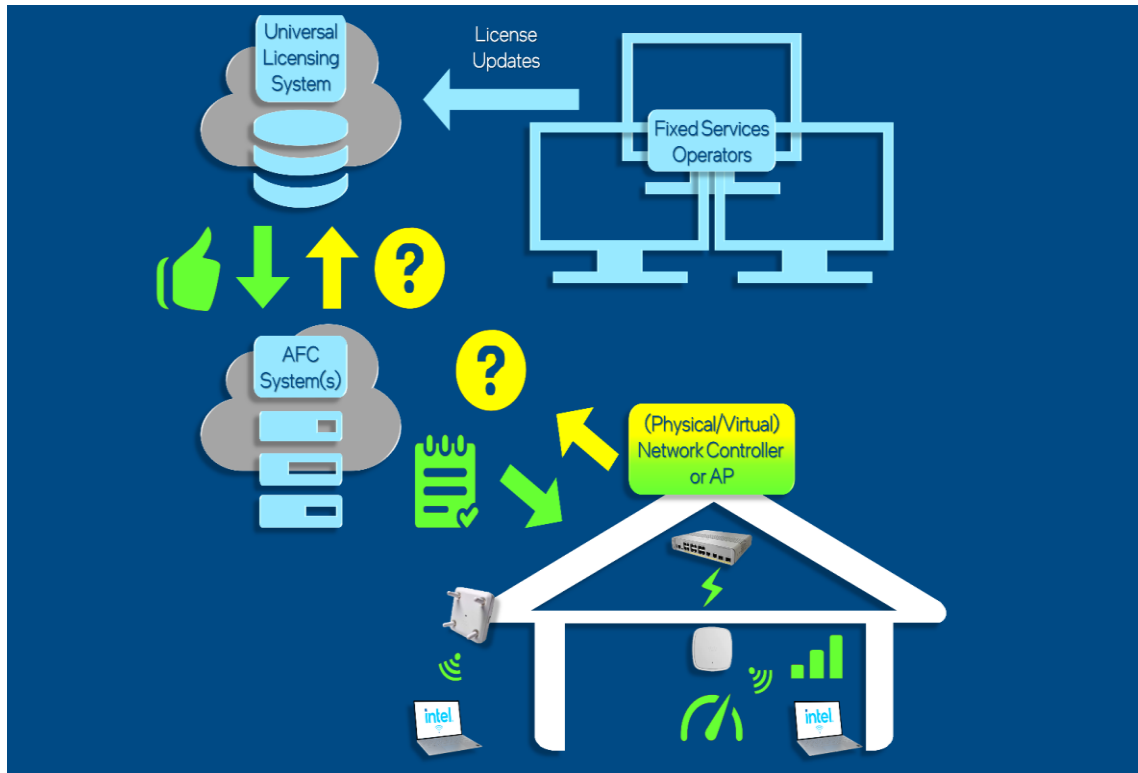

## FCC Requests 6 GHz Automated Frequency Coordination Proposals

<https://www.fcc.gov/document/fcc-requests-6-ghz-automated-frequency-coordination-proposals>

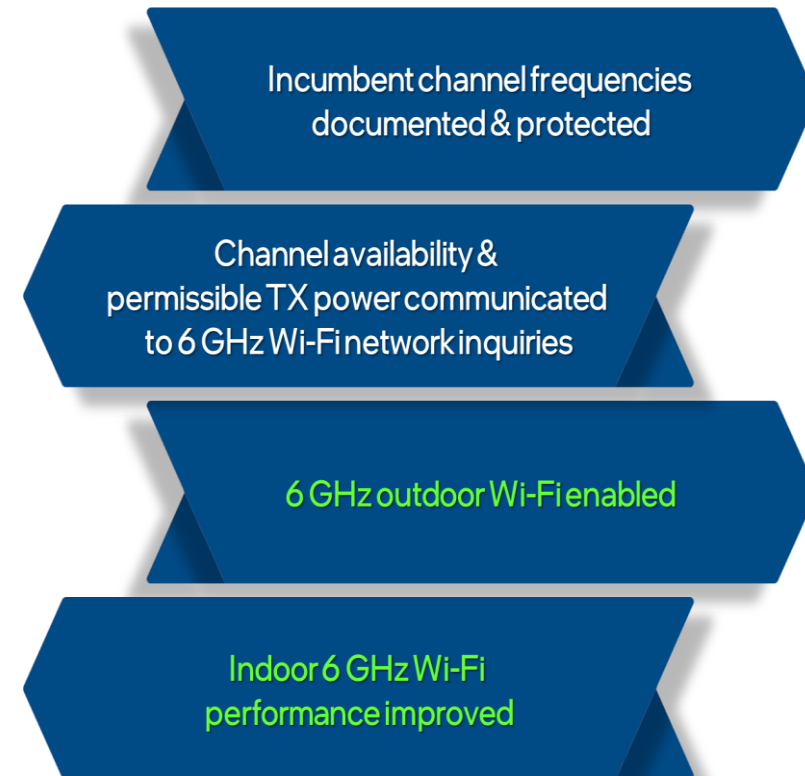

# Wi-Fi Continues to Transform the Landscape



## New Wi-Fi 7 innovations

- 320 MHz channels, multi-link operation, 4K-QAM, deterministic low latency

## Wi-Fi 7 will build on Wi-Fi 6/6E

- Optimal use of the 6 GHz band, even lower latency, even higher throughput, even higher reliability, even more secure

## Wi-Fi will become even better

- Video streaming, video/voice conferencing, wireless gaming, real-time collaboration, cloud/edge compute, industrial IoT, immersive AR/VR, interactive telemedicine, etc.
- OpenRoaming, Wi-Fi sensing, 6 GHz AFC and others

The future is bright for Wi-Fi!



# Notices & Disclaimers

6 GHz Wi-Fi laptop functionality requires Wi-Fi 6E/7 modules, Wi-Fi 6E/7 APs/Routers/Gateways, Operating System support for 6 GHz operation, along with country-specific 6 GHz spectrum allocation for non-licensed use and associated regional regulatory approvals. 6 GHz may not be available in some countries.

All product plans and roadmaps are subject to change without notice.

Statements in this document that refer to future plans or expectations are forward-looking statements. These statements are based on current expectations and involve many risks and uncertainties that could cause actual results to differ materially from those expressed or implied in such statements. For more information on the factors that could cause actual results to differ materially, see our most recent earnings release and SEC filings at [www.intc.com](http://www.intc.com).

For additional details, please visit [www.intel.com/performanceindex](http://www.intel.com/performanceindex) (Connectivity / Wireless / Wi-Fi)

Performance varies by use, configuration and other factors.

No product or component can be absolutely secure.

Intel technologies may require enabled hardware, software, operating system, or service activation.

Intel, the Intel logo, and other Intel marks are trademarks of Intel Corporation or its subsidiaries.

Other names and brands may be claimed as the property of others.

Copyright © Intel Corporation.

The Intel logo is centered on a solid blue background. It features the word "intel" in a white, lowercase, sans-serif font. A small blue square is positioned above the letter 'i'. To the right of the word "intel" is a registered trademark symbol (®).

intel®



# Sources for Slide 5

1. PLUME: People/Devices Average Active Online At Home during working hours Sep-2020 +73% vs. Jan-2020 (USA)
2. OPEN VAULT: Projected Avg HH BB usage per month Sep-2020 +40% YOY (OPEN VAULT = AMERICAS + EU)
3. NCTA: USA Sep-2020 peak US traffic +31% vs. March (more video conferencing)
4. Cisco, "Cisco Visual Networking Index: Global Mobile Data Traffic Forecast Update, 2017-2022". February 2019.
5. Pulse Security, "2020 Remote Work-From-Home Cybersecurity Report", May 2020.
6. Benton Institute for Broadband & Society, How Does the CARES Act Connect Us? April-2020.
7. 802.11ax 2x2 160MHz enables 2402Mbps maximum theoretical data rates, nearly 3x faster than standard 802.11ac 2x2 80MHz at 867Mbps ( $2402/867=2.8$ ), and nearly 6x faster than baseline 1x1ac at 433Mbps ( $2402/433=5.6$ ) Wi-Fi as documented in IEEE 802.11 wireless standard specifications and require the use of similarly configured 802.11ax wireless network routers.
8. Based on Intel simulation data of 802.11ax with and without OFDMA using 9 clients. Average latency without OFDM is 36ms, with OFDMA average latency is reduced to 7.6ms ( $1-(7.6/36) = 79\%$ ). Latency improvement requires that the AP and all clients support OFDMA.
9. This amendment defines standardized modifications to both the IEEE 802.11 physical layers (PHY) and the IEEE 802.11 Medium Access Control layer (MAC) that enable at least one mode of operation capable of supporting at least four times improvement in the average throughput per station (measured at the MAC data service access point) in a dense deployment scenario, while maintaining or improving the power efficiency per station. <https://mentor.ieee.org/802.11/dcn/14/11-14-0165-01-0hew-802-11-hew-sg-proposed-par.docx>
10. Wi-Fi 7 320MHz enables ~46.1 Gbps maximum theoretical data rate, nearly 5x faster than Wi-Fi 6 160MHz at ~9.6 Gbps maximum theoretical data rate ( $46.1/9.6=4.8$ ). Reported by Carlos Cordeiro, CTO Wireless Communication Solutions at Intel Corporation, [Webinar] Next Generation Wi-Fi: Wi-Fi 6, Wi-Fi 7 and Beyond", June 26, 2020.