

Dual-Core Intel® Itanium® Processor 9000 and 9100 Series

Dual-Core Intel® Itanium® Processor 1.6 GHz with 24 MB L3 Cache 9050
Dual-Core Intel® Itanium® Processor 1.6 GHz with 18 MB L3 Cache 9040
Dual-Core Intel® Itanium® Processor 1.6 GHz with 8 MB L3 Cache 9030
Dual-Core Intel® Itanium® Processor 1.42 GHz with 12 MB L3 Cache 9020
Dual-Core Intel® Itanium® Processor 1.4 GHz with 12 MB L3 Cache 9015
Intel® Itanium® Processor 1.6 GHz with 6 MB L3 Cache 9010
Dual-Core Intel® Itanium® Processor 1.66/1.6 GHz with 24 MB L3 Cache 9152
Dual-Core Intel® Itanium® Processor 1.66 GHz with 24 MB L3 Cache 9150M
Dual-Core Intel® Itanium® Processor 1.6 GHz with 24 MB L3 Cache 9150N
Dual-Core Intel® Itanium® Processor 1.66 GHz with 18 MB L3 Cache 9140M
Dual-Core Intel® Itanium® Processor 1.6 GHz with 18 MB L3 Cache 9140N
Dual-Core Intel® Itanium® Processor 1.42 GHz with 12 MB L3 Cache 9120N
Dual-Core Intel® Itanium® Processor 1.66 GHz with 8 MB L3 Cache 9130M
Intel® Itanium® Processor 1.6 GHz with 12 MB L3 Cache 9110N

Datasheet

October 2007



INFORMATION IN THIS DOCUMENT IS PROVIDED IN CONNECTION WITH INTEL® PRODUCTS. NO LICENSE, EXPRESS OR IMPLIED, BY ESTOPPEL OR OTHERWISE, TO ANY INTELLECTUAL PROPERTY RIGHTS IS GRANTED BY THIS DOCUMENT. EXCEPT AS PROVIDED IN INTEL'S TERMS AND CONDITIONS OF SALE FOR SUCH PRODUCTS, INTEL ASSUMES NO LIABILITY WHATSOEVER, AND INTEL DISCLAIMS ANY EXPRESS OR IMPLIED WARRANTY, RELATING TO SALE AND/OR USE OF INTEL PRODUCTS INCLUDING LIABILITY OR WARRANTIES RELATING TO FITNESS FOR A PARTICULAR PURPOSE, MERCHANTABILITY, OR INFRINGEMENT OF ANY PATENT, COPYRIGHT OR OTHER INTELLECTUAL PROPERTY RIGHT. Intel products are not intended for use in medical, life saving, life sustaining applications.

Intel may make changes to specifications and product descriptions at any time, without notice.

Designers must not rely on the absence or characteristics of any features or instructions marked "reserved" or "undefined." Intel reserves these for future definition and shall have no responsibility whatsoever for conflicts or incompatibilities arising from future changes to them

The Dual-Core Intel® Itanium® 9000 and 9100 series processor may contain design defects or errors known as errata which may cause the product to deviate from published specifications. Current characterized errata are available on request.

Contact your local Intel sales office or your distributor to obtain the latest specifications and before placing your product order.

Copies of documents which have an order number and are referenced in this document, or other Intel literature, may be obtained by calling 1-800-548-4725, or by visiting Intel's website at <http://www.intel.com>.

Intel, Itanium, and the Intel logo are trademarks or registered trademarks of Intel Corporation or its subsidiaries in the United States and other countries.

Copyright © 2002-2007, Intel Corporation

*Other names and brands may be claimed as the property of others.

I2C is a two-wire communication bus /protocol developed by Phillips. SMBus is a subset of the I2C bus/protocol developed by Intel. Implementation of the I2C bus/protocol or the SMBus bus/protocol may require licenses from various entities, including Phillips Electronics, N.V. and North American Phillips Corporation.



Contents

1	Introduction.....	11
1.1	Overview	11
1.2	Processor Abstraction Layer.....	11
1.3	Mixing Processors of Different Frequencies and Cache Sizes	12
1.4	Terminology	12
1.5	State of Data.....	12
1.6	Reference Documents	13
2	Electrical Specifications	15
2.1	Dual-Core Intel® Itanium® Processor 9000 and 9100 Series System Bus.....	15
2.1.1	System Bus Power Pins	15
2.1.2	System Bus No Connect	15
2.2	System Bus Signals.....	15
2.2.1	Signal Groups	15
2.2.2	Signal Descriptions	17
2.3	Package Specifications	18
2.4	Signal Specifications	18
2.4.1	Maximum Ratings.....	22
2.5	System Bus Signal Quality Specifications and Measurement Guidelines.....	23
2.5.1	Overshoot/Undershoot Magnitude.....	23
2.5.2	Overshoot/Undershoot Pulse Duration	24
2.5.3	Activity Factor.....	24
2.5.4	Reading Overshoot/Undershoot Specification Tables.....	24
2.5.5	Determining if a System Meets the Overshoot/Undershoot Specifications.....	25
2.5.6	Wired-OR Signals	25
2.6	Voltage Regulator Connector Signals.....	27
2.7	System Bus Clock and Processor Clocking.....	31
2.8	Recommended Connections for Unused Pins.....	33
3	Pinout Specifications	35
4	Mechanical Specifications.....	65
4.1	Processor Package Dimensions.....	65
4.1.1	Voltage Regulator (MVR) to Processor Package Interface.....	71
4.2	Package Marking	72
4.2.1	Processor Top-Side Marking	72
4.2.2	Processor Bottom-Side Marking	73
5	Thermal Specifications	75
5.1	Thermal Features	75
5.1.1	Thermal Alert.....	75
5.1.2	Enhanced Thermal Management	76
5.1.3	Power Trip.....	76
5.1.4	Thermal Trip.....	76
5.2	Case Temperature.....	76
6	System Management Feature Specifications	79
6.1	System Management Bus	79
6.1.1	System Management Bus Interface	79
6.1.2	System Management Interface Signals	79
6.1.3	SMBus Device Addressing	81
6.2	Processor Information ROM	82
6.3	Scratch EEPROM	85

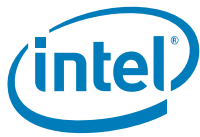

6.4	Processor Information ROM and Scratch EEPROM Supported SMBus Transactions	85
6.5	Thermal Sensing Device	86
6.6	Thermal Sensing Device Supported SMBus Transactions.....	87
6.7	Thermal Sensing Device Registers.....	88
6.7.1	Thermal Reference Registers	88
6.7.2	Thermal Limit Registers	89
6.7.3	Status Register	89
6.7.4	Configuration Register	89
6.7.5	Conversion Rate Register	90
A	Signals Reference	91
A.1	Alphabetical Signals Reference	91
A.1.1	A[49:3]# (I/O).....	91
A.1.2	A20M# (I)	91
A.1.3	ADS# (I/O).....	91
A.1.4	AP[1:0]# (I/O).....	91
A.1.5	ASZ[1:0]# (I/O).....	91
A.1.6	ATTR[3:0]# (I/O)	92
A.1.7	BCLKp/BCLKn (I)	92
A.1.8	BE[7:0]# (I/O).....	92
A.1.9	BERR# (I/O)	93
A.1.10	BINIT# (I/O).....	94
A.1.11	BNR# (I/O).....	94
A.1.12	BPM[5:0]# (I/O)	94
A.1.13	BPRI# (I)	94
A.1.14	BR[0]# (I/O) and BR[3:1]# (I).....	94
A.1.15	BREQ[3:0]# (I/O).....	95
A.1.16	CCL# (I/O)	96
A.1.17	CPUPRES# (O)	96
A.1.18	D[127:0]# (I/O).....	96
A.1.19	D/C# (I/O)	96
A.1.20	DBSY# (I/O).....	96
A.1.21	DBSY_C1# (O)	96
A.1.22	DBSY_C2# (O)	96
A.1.23	DEFER# (I).....	96
A.1.24	DEN# (I/O).....	97
A.1.25	DEP[15:0]# (I/O)	97
A.1.26	DHIT# (I)	97
A.1.27	DPS# (I/O).....	98
A.1.28	DRDY# (I/O).....	98
A.1.29	DRDY_C1# (O).....	98
A.1.30	DRDY_C2# (O).....	98
A.1.31	DSZ[1:0]# (I/O)	98
A.1.32	EXF[4:0]# (I/O)	98
A.1.33	FCL# (I/O)	99
A.1.34	FERR# (O).....	99
A.1.35	GSEQ# (I)	99
A.1.36	HIT# (I/O) and HITM# (I/O)	99
A.1.37	ID[9:0]# (I)	99
A.1.38	IDS# (I)	99
A.1.39	IGNNE# (I).....	99
A.1.40	INIT# (I).....	99
A.1.41	INT (I)	100
A.1.42	IP[1:0]# (I).....	100
A.1.43	LEN[2:0]# (I/O)	100
A.1.44	LINT[1:0] (I)	100

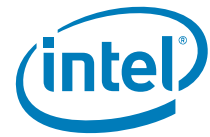

A.1.45	LOCK# (I/O)	100
A.1.46	NMI (I)	101
A.1.47	OWN# (I/O)	101
A.1.48	PMI# (I)	101
A.1.49	PWRGOOD (I)	101
A.1.50	REQ[5:0]# (I/O)	101
A.1.51	RESET# (I)	102
A.1.52	RP# (I/O)	102
A.1.53	RS[2:0]# (I)	103
A.1.54	RSP# (I)	103
A.1.55	SBSY# (I/O)	103
A.1.56	SBSY_C1# (O)	103
A.1.57	SBSY_C2# (O)	103
A.1.58	SPLCK# (I/O)	103
A.1.59	STBn[7:0]# and STBp[7:0]# (I/O)	103
A.1.60	TCK (I)	104
A.1.61	TDI (I)	104
A.1.62	TDO (O)	104
A.1.63	THRMTRIP# (O)	104
A.1.64	THRMALERT# (O)	104
A.1.65	TMS (I)	104
A.1.66	TND# (I/O)	104
A.1.67	TRDY# (I)	105
A.1.68	TRST# (I)	105
A.1.69	WSNP# (I/O)	105
A.2	Signal Summaries	105

Figures

2-1	Generic Clock Waveform	21
2-2	SMSC Clock Waveform	22
2-3	System Bus Signal Waveform Exhibiting Overshoot/Undershoot	23
2-4	Processors Power Tab Physical Layout	28
2-5	System Bus Reset and Configuration Timings for Cold Reset	31
2-6	System Bus Reset and Configuration Timings for Warm Reset	32
3-1	Dual-Core Intel® Itanium® Processor 9000 and 9100 Series Pinout	35
4-1	Processor Package	66
4-2	Package Height and Pin Dimensions	67
4-3	Processor Package Mechanical Interface Dimensions	69
4-4	Processor Package Top-Side Components Height Dimensions	70
4-5	Processor Package Bottom-Side Components Height Dimensions	70
4-6	Processor to MVR Interface Loads	71
4-7	Processor Top-Side Marking on IHS	73
4-8	Processor Bottom-Side Marking Placement on Interposer	74
5-1	Dual-Core Intel® Itanium® Processor 9000 and 9100 Series Thermal Features	75
5-2	Itanium® Processor Package Thermocouple Location	77
6-1	Logical Schematic of SMBus Circuitry	80

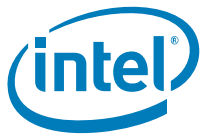

Tables

2-1	Itanium [®] Processor System Bus Signal Groups	16
2-2	Nominal Resistance Values for Tuner1, Tuner2, and Tuner3	17
2-3	Processor Package Specifications	18
2-4	AGTL+ Signals DC Specifications	19
2-5	Power Good Signal DC Specifications	19
2-6	System Bus Clock Differential HSTL DC Specifications	19
2-7	TAP Connection DC Specifications	19
2-8	SMBus DC Specifications	20
2-9	LVTTTL Signal DC Specifications	20
2-10	System Bus Clock Differential HSTL AC Specifications	20
2-11	SMBus AC Specifications	21
2-12	Dual-Core Intel [®] Itanium [®] Processor Absolute Maximum Ratings	22
2-13	Source Synchronous AGTL+ Signal Group and Wired-OR Signal Group Absolute Overshoot/Undershoot Tolerance	25
2-14	Source Synchronous AGTL+ Signal Group Time-Dependent Overshoot/ Undershoot Tolerance for 400-MHz System Bus	26
2-15	Wired-OR Signal Group (BINIT#, HIT#, HITM#, BNR#, TND#, BERR#) Overshoot/Undershoot Tolerance for 400-MHz System Bus	26
2-16	Source Synchronous AGTL+ Signal Group Time-Dependent Overshoot/ Undershoot Tolerance for 533-MHz System Bus	26
2-17	Wired-OR Signal Group (BINIT#, HIT#, HITM#, BNR#, TND#, BERR#) Overshoot/Undershoot Tolerance for 533-MHz System Bus	27
2-18	VR Connector Signals	27
2-19	Power Connector Pinouts	28
2-20	Processors Core Voltage Identification Code (VCORE and VCACHE)	30
2-21	Connection for Unused Pins	33
2-22	TUNER1/TUNER3 Translation Table	34
3-1	Pin/Signal Information Sorted by Pin Name	36
3-2	Pin/Signal Information Sorted by Pin Location	50
4-1	Processor Package Dimensions	67
4-2	Processor Package Mechanical Interface Dimensions	68
4-3	Processor Package Load Limits at Power Tab	71
5-1	Case Temperature Specification	77
6-1	System Management Interface Signal Descriptions	79
6-2	Thermal Sensing Device SMBus Addressing on the Dual-Core Intel [®] Itanium [®] Processor 9000 and 9100 series	81
6-3	EEPROM SMBus Addressing on the Dual-Core Intel [®] Itanium [®] Processor 9000 and 9100 Series	82
6-4	Processor Information ROM Format	82
6-5	Current Address Read SMBus Packet	85
6-6	Random Address Read SMBus Packet	86
6-7	Byte Write SMBus Packet	86
6-8	Write Byte SMBus Packet	87
6-9	Read Byte SMBus Packet	87
6-10	Send Byte SMBus Packet	87
6-11	Receive Byte SMBus Packet	87
6-12	ARA SMBus Packet	87
6-13	Command Byte Bit Assignment	88
6-14	Thermal Sensing Device Status Register	89
6-15	Thermal Sensing Device Configuration Register	89
6-16	Thermal Sensing Device Conversion Rate Register	90

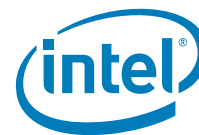

A-1	Address Space Size	92
A-2	Effective Memory Type Signal Encoding	92
A-3	Special Transaction Encoding on Byte Enables	93
A-5	BR0# (I/O), BR1#, BR2#, BR3# Signals for 2P Rotating Interconnect	95
A-4	BR0# (I/O), BR1#, BR2#, BR3# Signals for 4P Rotating Interconnect	95
A-6	BR[3:0]# Signals and Agent IDs	95
A-7	DID[9:0]# Encoding	97
A-8	Extended Function Signals	98
A-9	Length of Data Transfers	100
A-10	Transaction Types Defined by REQa#/REQb# Signals	102
A-11	STBp[7:0]# and STBn[7:0]# Associations	104
A-12	Output Signals	105
A-13	Input Signals	105
A-14	Input/Output Signals (Single Driver)	106
A-15	Input/Output Signals (Multiple Driver)	107



Revision History

Document Number	Revision Number	Description	Date
314054	-002	<ul style="list-style-type: none">Updated with 9100 series product information; updated brand name from "Itanium 2" to "Itanium".	October 2007
314054	-001	<ul style="list-style-type: none">Initial release of the document.	July 2006



Dual-Core Intel® Itanium® Processor 9000 and 9100 Series

Dual-Core Intel® Itanium® Processor 1.6 GHz with 24 MB L3 Cache 9050

Dual-Core Intel® Itanium® Processor 1.6 GHz with 18 MB L3 Cache 9040

Dual-Core Intel® Itanium® Processor 1.6 GHz with 8 MB L3 Cache 9030

Dual-Core Intel® Itanium® Processor 1.42 GHz with 12 MB L3 Cache 9020

Dual-Core Intel® Itanium® Processor 1.4 GHz with 12 MB L3 Cache 9015

Intel® Itanium® Processor 1.6 GHz with 6 MB L3 Cache 9010

Dual-Core Intel® Itanium® Processor 1.66 GHz with 24 MB L3 Cache 9150M

Dual-Core Intel® Itanium® Processor 1.6 GHz with 24 MB L3 Cache 9150N

Dual-Core Intel® Itanium® Processor 1.66 GHz with 18 MB L3 Cache 9140M

Dual-Core Intel® Itanium® Processor 1.6 GHz with 18 MB L3 Cache 9140N

Dual-Core Intel® Itanium® Processor 1.42 GHz with 12 MB L3 Cache 9120N

Dual-Core Intel® Itanium® Processor 1.66 GHz with 8 MB L3 Cache 9130M

Intel® Itanium® Processor 1.6 GHz with 12 MB L3 Cache 9110N

Product Features

- Dual Core
 - Two complete 64-bit processing cores on one processor.
- EPIC (Explicitly Parallel Instruction Computing) Technology for current and future requirements of high-end enterprise and technical workloads
 - Provide a variety of advanced implementations of parallelism, predication, and speculation, resulting in superior Instruction-Level Parallelism (ILP).
- Hyper-Threading Technology
 - Two times the number of OS threads per core provided by earlier single-thread implementations.
- Wide, parallel hardware based on Intel® Itanium® architecture for high performance:
 - Integrated on-die L3 cache of up to 24MB; cache hints for L1, L2, and L3 caches for reduced memory latency.
 - 128 general and 128 floating-point registers supporting register rotation.
 - Register stack engine for effective management of processor resources.
 - Support for predication and speculation.
- Extensive RAS features for business-critical applications:
 - Full SMBus compatibility.
 - Enhanced machine check architecture with extensive ECC and parity protection.
 - Enhanced thermal management.
 - Built-in processor information ROM (PIROM).
 - Built-in programmable EEPROM.
 - Socket Level Lockstep
 - Core Level Lockstep
- Intel® Virtualization Technology for virtualization for data-intensive applications.
 - Reduces virtualization complexity.
 - Improves virtualization performance.
 - Increases operating system compatibility.
- Intel® Cache Safe Technology ensures mainframe-caliber availability.
 - Minimize L3 cache errors.
- Outstanding Energy Efficiency.
 - 20 percent less power than previous Intel Itanium processor.
 - 2.5 times higher performance per watt.
- High-bandwidth system bus for multiprocessor scalability:
 - Up to 8.53GB/s bandwidth.
 - 128-bit wide data bus.
 - 50-bits of physical memory addressing and 64-bits of virtual addressing.
 - Up to four physical processors on the same system bus at 400-MHz or 533-MHz data bus frequency.
 - Expandable to systems with multiple system buses.
- Features to support flexible platform environments:
 - IA-32 Execution Layer supports IA-32 application binaries.
 - Bi-endian support.
 - Processor abstraction layer eliminates processor dependencies.
- 667-MHz, 1.66-GHz, 3-load bus^a
 - This feature enables increased bandwidth for Enterprise and HPC.
- Demand Based Switching (DBS)^a
 - Provides additional power management capability.

a. This feature is applicable to only the 9100 series processors

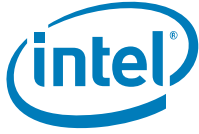

The Dual-Core Intel® Itanium® processor 9000 and 9100 series delivers new levels of flexibility, reliability, performance, and cost-effective scalability for your most data-intensive business and technical applications. With double the performance of previous Intel Itanium processors, the Dual-Core Intel Itanium processor 9000 and 9100 series provides more reasons than ever to migrate your business-critical applications off RISC and mainframe systems and onto cost-effective Intel architecture servers. The Dual-Core Intel Itanium processor 9000 and 9100 series provides close to triple the amount of L3 cache (24 megabytes), Hyper-Threading Technology for increased performance, Intel® Virtualization Technology for improved virtualization, Intel® Cache Safe Technology for increased availability, and 20 percent lower power consumption.

Dual-Core Itanium®-based systems are available from leading OEMs worldwide and run popular 64-bit operating systems such as Microsoft* Windows Server* 2003; Linux* from SuSE, Red Hat, Red Flag, and other distributions; HP NonStop*; OpenVMS*; and HP-UX*. More than 7,000 applications are available for Itanium-based systems, from vendors such as Microsoft, BEA, IBM, Ansys, Gaussian, Symantec/VERITAS, Oracle, SAP, and SAS. And with industry support growing and future Intel Itanium processor family advances already in development, your Itanium-based server investment will continue to deliver performance advances and savings for your most demanding applications.

§

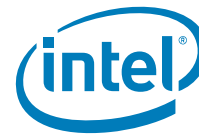

1 Introduction

1.1 Overview

The Dual-Core Intel Itanium processor 9000 and 9100 series employs Explicitly Parallel Instruction Computing (EPIC) design concepts for a tighter coupling between hardware and software. In this design style, the interface between hardware and software is engineered to enable the software to exploit all available compile-time information and efficiently deliver this information to the hardware. It addresses several fundamental performance bottlenecks in modern computers, such as memory latency, memory address disambiguation, and control flow dependencies. The EPIC constructs provide powerful architectural semantics and enable the software to make global optimizations across a large scheduling scope, thereby exposing available Instruction Level Parallelism (ILP) to the hardware. The hardware takes advantage of this enhanced ILP, and provides abundant execution resources. Additionally, it focuses on dynamic run-time optimizations to enable the compiled code schedule to flow at high throughput. This strategy increases the synergy between hardware and software, and leads to greater overall performance.

The Dual-Core Intel Itanium processor 9000 and 9100 series provides a 6-wide and 8-stage deep pipeline, running at up to 1.6 GHz. This provides a combination of abundant resources to exploit ILP as well as increased frequency for minimizing the latency of each instruction. The resources consist of six integer units, six multimedia units, two load and two store units, three branch units, two extended-precision floating-point units, and one additional single-precision floating-point unit per core. The hardware employs dynamic prefetch, branch prediction, a register scoreboard, and non-blocking caches to optimize for compile-time non-determinism. Three levels of on-die cache minimize overall memory latency. This includes up to a 24 MB L3 cache, accessed at core speed, providing up to 8.53 GB/sec. of data bandwidth. The system bus is designed to support up to four physical processors (on a single system bus), and can be used as an effective building block for very large systems. The balanced core and memory subsystem provide high performance for a wide range of applications ranging from commercial workloads to high-performance technical computing.

The Dual-Core Intel Itanium processor 9000 and 9100 series supports a range of computing needs and configurations from a two-way to large SMP servers. This document provides the electrical, mechanical and thermal specifications for the Dual-Core Intel Itanium processor 9000 and 9100 series for use while employing systems with the processors.

1.2 Processor Abstraction Layer

The Dual-Core Intel Itanium processor 9000 and 9100 series requires implementation-specific Processor Abstraction Layer (PAL) firmware. PAL firmware supports processor initialization, error recovery, and other functionality. It provides a consistent interface to system firmware and operating systems across processor hardware implementations. The *Intel® Itanium® Architecture Software Developer's Manual, Volume 2: System Architecture*, describes PAL. Platforms must provide access to the firmware address space and PAL at reset to allow the processors to initialize.

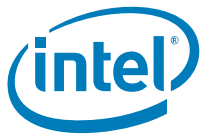

The System Abstraction Layer (SAL) firmware contains platform-specific firmware to initialize the platform, boot to an operating system, and provide runtime functionality. Further information about SAL is available in the *Intel® Itanium® Processor Family System Abstraction Layer Specification*.

1.3 Mixing Processors of Different Frequencies and Cache Sizes

All Dual-Core Intel Itanium processor 9000 and 9100 series on the same system bus are required to have the same cache size (24 MB, 18 MB, 12 MB, 8 MB or 6 MB) and identical core frequency. Mixing components of different core frequencies and cache sizes is not supported and has not been validated by Intel. Operating system support for multiprocessing with mixed components should also be considered.

While Intel has done nothing to specifically prevent processors within a multiprocessor environment from operating at differing frequencies and differing cache sizes, there may be uncharacterized errata that exist in such configurations. Customers would be fully responsible for validation of system configurations with mixed components other than the supported configurations described above.

1.4 Terminology

In this document, “the processor” refers to the “Dual-Core Intel Itanium processor 9000 and 9100 series” processor, unless otherwise indicated.

A ‘#’ symbol after a signal name refers to an active low signal. This means that a signal is in the active state (based on the name of the signal) when driven to a low level. For example, when RESET# is low, a processor reset has been requested. When NMI is high, a non-maskable interrupt has occurred. In the case of lines where the name does not imply an active state but describes part of a binary sequence (such as address or data), the ‘#’ symbol implies that the signal is inverted. For example, D[3:0] = ‘HLHL’ refers to a hex ‘A’, and D [3:0] # = ‘LHLH’ also refers to a hex ‘A’ (H = High logic level, L = Low logic level).

The term “system bus” refers to the interface between the processor, system core logic, and other bus agents. The system bus is a multiprocessing interface to processors, memory, and I/O.

A signal name has all capitalized letters, for example, VCTERM.

A symbol referring to a voltage level, current level, or a time value carries a plain subscript, for example, V_{core} , or a capitalized, abbreviated subscript, for example, T_{CO} .

1.5 State of Data

The data contained in this document is subject to change. It is the best information that Intel is able to provide at the publication date of this document.



1.6 Reference Documents

The reader of this specification should also be familiar with material and concepts presented in the following documents:

<i>Intel® Itanium® 2 Processor Specification Update</i>
<i>Intel® Itanium® Architecture Software Developer's Manual, Volume 1: Application Architecture</i>
<i>Intel® Itanium® Architecture Software Developer's Manual, Volume 2: System Architecture</i>
<i>Intel® Itanium® Architecture Software Developer's Manual, Volume 3: Instruction Set Reference</i>
<i>Intel® Itanium® 2 Processor Reference Manual for Software Development and Optimization</i>
<i>Intel® Itanium® Processor Family System Abstraction Layer Specification</i>
<i>ITP700 Debug Port Design Guide</i>
System Management Bus Specification

Note: Contact your Intel representative or check <http://developer.intel.com> for the latest revision of the reference documents.





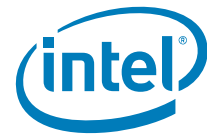

2 Electrical Specifications

This chapter describes the electrical specifications of the Dual-Core Intel Itanium Processor 9000 and 9100 series.

2.1 Dual-Core Intel® Itanium® Processor 9000 and 9100 Series System Bus

Most Dual-Core Intel Itanium processor 9000 and 9100 series signals use the Itanium processor's assisted gunning transceiver logic (AGTL+) signaling technology. The termination voltage, V_{CTERM} , is generated on the baseboard and is the system bus high reference voltage. The buffers that drive most of the system bus signals on the processor are actively driven to V_{CTERM} during a low-to-high transition to improve rise times and reduce noise. These signals should still be considered open-drain and require termination to V_{CTERM} which provides the high level. The processor system bus is terminated to V_{CTERM} at each end of the bus. There is also support of off-die termination, in which case, the termination is provided by external resistors connected to V_{CTERM} .

AGTL+ inputs use differential receivers which require a reference signal (V_{REF}). V_{REF} is used by the receivers to determine if a signal is a logical 0 or a logical 1. The processor generates V_{REF} on-die, thereby eliminating the need for an off-chip reference voltage source.

2.1.1 System Bus Power Pins

V_{CTERM} (1.2 V) input pins on the processor provide power to the driver buffers and on-die termination. The GND pins, in addition to the GND input at the power tab connector, provide ground to the processor. Power for the processor core is supplied through the power tab connector by V_{Core} , V_{Cache} , V_{fixed} . The 3.3 V pin is included on the processor to provide power to the system management bus (SMBus). The V_{CTERM} , 3.3 V, and GND pins must remain electrically separated from each other.

2.1.2 System Bus No Connect

All pins designated as "N/C" or "No Connect" must remain unconnected.

2.2 System Bus Signals

2.2.1 Signal Groups

Table 2-1 shows processor system bus signals that have been combined into groups by buffer type and whether they are inputs, outputs, or bidirectional, with respect to the processor.



Table 2-1. Itanium® Processor System Bus Signal Groups

Group Name	Signals
AGTL+ Input Signals	BPRI#, BR[3:1]#, DEFER#, GSEQ#, ID[9:0]#, IDS#, RESET# ¹ , RS[2:0]#, RSP#, TRDY#
AGTL+ I/O Signals	A[49:3]#, ADS#, AP[1:0]#, BERR#, BINIT#, BNR#, BPM[5:0]# ¹ , BRO#, D[127:0]#, DBSY#, DEP[15:0]#, DRDY#, HIT#, HITM#, LOCK#, REQ[5:0]#, RP#, SBSY#, STBN[7:0]#, STBP[7:0]#, TND#
AGTL+ Output Signals	FERR#, THRMTRIP#, DBSY[1:0]#, DRDY[1:0]#, SBSY[1:0]#
Special AGTL+ Asynchronous Interrupt Input Signals	A20M#, IGNNE#, INIT#, LINT[1,0], PMI#
Power Good Signal ¹	PWRGOOD
HSTL Clock Signals	BCLKn, BCLKp
TAP Input Signals ¹	TCK, TDI, TMS, TRST#
TAP Output Signals ¹	TDO
System Management Signals ¹	3.3 V, SMA[2:0], SMSC, SMSD, SMWP, THRMALERT#
Power Signals	GND, VCTERM
LVTTTL Power Pod Signals ¹	CPUPRES#, OUTEN, PPODGD#
Other	TERMA, TERMB, TUNER1, TUNER2, TUNER3, VCCMON, VSSMON

Notes:

1. Signals will not be terminated on-die even when on-die termination (ODT) is enabled. See the *Intel® Itanium® 2 Processor Hardware Developer's Manual* for further details.

All system bus outputs should be treated as open drain signals and require a high-level source provided by the V_{CTERM} supply.

AGTL+ inputs have differential input buffers which use V_{REF} as a reference level. AGTL+ output signals require termination to V_{CTERM}. In this document, "AGTL+ Input Signals" refers to the AGTL+ input group as well as the AGTL+ I/O group when receiving. Similarly, "AGTL+ Output Signals" refers to the AGTL+ output group as well as the AGTL+ I/O group when driving.

The Test Access Port (TAP) connection input signals use a non-differential receiver with levels that are similar to AGTL+. No reference voltage is required for these signals. The TAP Connection Output signals are AGTL+ output signals.

The processor system bus requires termination on both ends of the bus. The processor system bus supports both on-die and off-die termination controlled by two pins, TERMA and TERMB. Please see the TERMA and TERMB pin description in [Section 2.2.2](#).

The HSTL clock signals are the differential clock inputs for the processor. The SMBus signals and LVTTTL power pod signals are driven using the 3.3 V CMOS logic levels listed in [Table 2-8](#) and [Table 2-9](#), respectively.

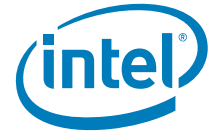

2.2.2 Signal Descriptions

Appendix A, “Signals Reference”, contains functional descriptions of all system bus signals and LVTTTL power pod signals. Further descriptions of the system management signals are contained in Chapter 6. The signals listed under the “Power” and “Other” group are described here:

V _{CTERM}	System bus termination voltage.
GND	System ground.
N/C	No connection can be made to these pins.
TERMA, TERMB	The processor uses two pins to control the on-die termination function: TERMA and TERMB. Both of these termination pins must be pulled to V _{CTERM} in order to terminate the system bus using the on-die termination resistors. Both of these termination pins must be pulled to GND in order to use off-die termination.
TUNER1, TUNER2, TUNER3	The TUNER1 Pin can either be left as a no-connect or left connected to V _{CTERM} via resistor for the majority of platforms supporting the Dual-Core Intel Itanium processor 9000 and 9100 series. The TUNER2 resistor is used to control the termination resistance for the system bus I/O buffers. A lower resistance will cause a lower on-die termination resistance. On-die termination mode will only be selected if the TERMA and TERMB pins are terminated as indicated above. The TUNER3 pin will not be required for the majority of platforms supporting the Dual-Core Intel Itanium processor 9000 and 9100 series. The TUNER3 pin is used only in the case where A[21:17]# are driven to all zeros or all ones during the configuration cycles at reset. When all zeros or all ones are observed by the processor the presence of the TUNER3 and TUNER1 pins is used to determine system bus frequency. See Table 2-22 for the various TUNER pin combinations and resulting system bus frequency and slew rate combination.
VCCMON, VSSMON	These pins allows remote measurement of on-die V _{core} voltage. No connections that constitute a current load can be made to these pins.

Table 2-2. Nominal Resistance Values for Tuner1, Tuner2, and Tuner3

400 MHz 5-Load Platform (Ohms)	400 MHz 3-Load Platform (Ohms)	533 MHz 3-Load Platform (Ohms)
Tuner1: NC ¹ Tuner2: 150 Tuner3: NC ¹	Tuner1: NC ¹ Tuner2: 150 Tuner3: NC ¹	Tuner1: NC ¹ Tuner2: 150 Tuner3: NC ¹

Notes:

- Depending on system configuration, the processor may or may not require a resistor on the TUNER pin. OEMs may leave the pin unconnected or connect it to V_{CTERM} through a 150 or 100 ohm resistor. If A[21:17]:# are driven to all 0's or all 1's at reset, see Table 2-22 for proper use of the TUNER Pins.

2.3 Package Specifications

Table 2-3 through Table 2-9 list the DC voltage, current, and power specifications for the processor. The voltage and current specifications are defined at the processor pins. Operational specifications listed in Table 2-3 through Table 2-9 are only valid while meeting specifications for case temperature, clock frequency, and input voltages.

Table 2-3. Processor Package Specifications

Symbol	Parameter	Core Frequency	Minimum	Typ	Maximum	Unit	Notes
V _{core, PS}	V _{CC} from the Voltage Regulator	All	VID-17 mV	VID	VID+17 mV	V	¹
V _{cache, PS}	V _{cache} from the Voltage Regulator	All	VID-17 mV	VID	VID+17 mV	V	²
V _{fixed, PS}	V _{fixed} from the Voltage Regulator	All	1.25-20 mV	1.25	1.25+20 mV	V	
V _{CTERM}	Termination Voltage	All	1.2-1.5%	1.2	1.2+1.5%	V	
R _{TERM}	Recommended Termination Resistance	All	45-15%	45	45+15%	Ohm	³
V _{TAP}	Test Access Port Voltage (V _{CC} TAP)	All	1.2-1.5%	1.2	1.5	V	
I _{core, PS}	Core Current Required from Power Supply	All	2.8	89	121	A	
I _{cache, PS}	Cache Current Required from Power Supply	All	2.0	17	18	A	
I _{fixed, PS}	Fixed Current Required from Power Supply	All	0.7	9.2	11	A	
I _{CTERM}	Termination Voltage Current	All			7.2	A	⁴
PS _{TT}	Power Supply Slew Rate for the Termination Voltage at the Processor Pins	All			0.05	A/ns	
PWR _{max}	Max Power	All			177	W	⁵
PWR _{TPE}	Thermal Power Envelope	All			130	W	
PWR _{TDP}	Thermal Design Power – dual core	All			104	W	⁶
	Thermal Design Power – single core	1.6 GHz			75	W	

Notes:

1. The range for V_{core} is 1.0875 V to 1.25 V.
2. V_{cache} typical is 1.025 V.
3. The processor system bus is terminated at each end of the system bus. The processor supports both on-die and off-die termination which is selected by the TERMA and TERMB pins. Termination tolerance is ±15% for on-die termination measured at V_{OL} and ±1% for off-die termination.
4. This is measured for On-Die Termination with a 45-ohm pull up resistor.
5. Max power is peak electrical power that must be provided for brief periods by the VR.
6. Represents the TDP level that should be used for system thermal design. Sustained power for all real-world applications will remain at or below this power level.

2.4 Signal Specifications

This section describes the DC specifications of the system bus signals. The processor signal's DC specifications are defined at the processor pins. Table 2-4 through Table 2-9 describe the DC specifications for the AGTL+, PWRGOOD, HSTL clock, TAP port, system management, and LVTTTL signals. Please refer to the *ITP700 Debug Port Design Guide* for the TAP connection signals' DC specifications at the debug port.

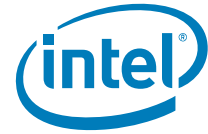

Table 2-4. AGTL+ Signals DC Specifications

Symbol	Parameter	Core Frequency	Minimum	Typ	Maximum	Unit	Notes
V _{IL}	Input Low Voltage	All			0.625	V	1
V _{IH}	Input High Voltage	All	0.875			V	1
V _{OL}	Output Low Voltage	All		0.3	0.4	V	2
V _{OH}	Output High Voltage	All	V _{CTERM, minimum}	V _{CTERM}	V _{CTERM, maximum}	V	
I _{OL}	Output Low Current @ 0.3 V	All	34			mA	3
I _{OL}	Output Low Current @ 0.3 V	All	17			mA	4
I _L	Leakage Current	All			±100	µA	5
C _{AGTL+}	AGTL+ Pad Capacitance	All			2	pF	6

Notes:

1. The typical transition point between V_{IL} and V_{IH} assuming 125 mV V_{REF} uncertainty for ODT. V_{REF,high} and V_{REF,low} levels are V_{REF} ±100 mV, respectively, for a system bus agent using on-board termination. V_{REF,high} and V_{REF,low} levels are V_{REF} ±125 mV, respectively, for a system bus agent using on-die termination.
2. Parameter measured into a 22.5 ohm resistor to 1.2 V. Minimum V_{OL} and I_{OL} are guaranteed by design/characterization.
3. Calculated using off-die termination through two 45 ohm ±1% resistors in parallel.
4. Calculated using on-die termination to a 45 ±15% resistor measured at V_{OL}.
5. At 1.2 V ±1.5%. V_{CTERM, minimum} ≤ V_{pin} ≤ V_{CTERM, maximum}.
6. Total of I/O buffer with ESD structure and processor parasitics if applicable. Capacitance values guaranteed by design for all AGTL+ buffers.

Table 2-5. Power Good Signal DC Specifications

Symbol	Parameter	Minimum	Maximum	Unit	Notes
V _{IL}	Input Low Voltage		0.440	V	
V _{IH}	Input High Voltage	0.875		V	

Table 2-6. System Bus Clock Differential HSTL DC Specifications

Symbol	Parameter	Minimum	Maximum	Unit	Notes
V _{IH}	Input High Voltage	0.78	1.3	V	
V _{IL}	Input Low Voltage	-0.3	0.5	V	
V _X	Input Crossover Voltage	0.55	0.85	V	
C _{CLK}	Input (Pad) Capacitance		1.75	pF	

Table 2-7. TAP Connection DC Specifications

Symbol	Parameter	Minimum	Maximum	Unit	Notes
V _{IL}	Input Low Voltage	-0.3	0.5	V	1
V _{IH}	Input High Voltage	1.1	1.57	V	1, 2
V _{OL}	Output Low Voltage		0.3	V	
V _{OH}	Output High Voltage	1.2		V	2, 3
I _{OL}	Output Low Current	20		mA	
I _{IC}	Input Current		690	µA	4

Notes:

1. There is a 100 mV hysteresis on TCK.
2. V_{IH, MAX} = 1.5 V + 5%, V_{OH, MAX} = 1.2 V + 5%.
3. There is no internal pull-up. An external pull-up is always assumed. Max voltage tolerated at TDO is 1.5 V.
4. Per input pin.



Table 2-8. SMBus DC Specifications

Symbol	Parameter	Minimum	Typ	Maximum	Unit	Notes
3.3V	V _{CC} for the System Management Components	3.14	3.3	3.47	V	3.3 V ±5
V _{IL}	Input Low Voltage	-0.3		0.3*3.3 V	V	
V _{IH}	Input High Voltage	2.31		3.47	V	Max = 3.3 +5% Min + 0.7*3.3V
V _{OL}	Output Low Voltage			0.4	V	
I _{3.3V}	3.3V Supply Current		5.0	30.0	mA	
I _{OL}	Output Low Current			3	mA	1
I _{OL2}	Output Low Current	6			mA	2
I _{LI}	Input Leakage Current			10	µA	
I _{LO}	Output Leakage Current			10	µA	

Notes:

1. The value specified for I_{OL} applies to all signals except for THRMALERT#.
2. The value specified for I_{OL2} applies only to THRMALERT#, which is an open drain signal.

Table 2-9. LVTTTL Signal DC Specifications

Symbol	Parameter	Minimum	Maximum	Unit	Notes
V _{IL}	Input Low Voltage		0.8	V	
V _{IH}	Input High Voltage	2.0	3.63	V	
V _{OL}	Output Low Voltage		0.4	V	
V _{OH}	Output High Voltage	2.4		V	

Table 2-10 through Table 2-11 list the AC specifications for the processor’s clock and SMBus (timing diagrams begin with Figure 2-1). The processor uses a differential HSTL clocking scheme with a frequency of 200, 266, or 333 MHz. The SMBus is a subset of the I2C* interface which supports operation of up to 100 kHz.

Table 2-10. System Bus Clock Differential HSTL AC Specifications (Sheet 1 of 2)

Symbol	Parameter	System Bus Clock (MHz)	Minimum	Typ	Maximum	Unit	Figure	Notes
T _{period}	BCLKp Period	200		5.0		ns	Figure 2-1	
T _{skew}	System Clock Skew	200		100		ps		1
f _{BCLK}	BCLKp Frequency	200	200		200	MHz	Figure 2-1	2
T _{Jitter}	BCLKp Input Jitter	200			100	ps	Figure 2-1	3
T _{high}	BCLKp High Time	200	2.25	2.5	2.75	ns	Figure 2-1	4
T _{low}	BCLKp Low Time	200	2.25	2.5	2.75	ns	Figure 2-1	4
T _{period}	BCLKp Period	266		3.75		ns	Figure 2-1	
T _{skew}	System Clock Skew	266			60	ps		5
f _{BCLK}	BCLKp Frequency	266	266		266	MHz	Figure 2-1	2
T _{Jitter}	BCLKp Input Jitter	266			50	ps	Figure 2-1	3
T _{high}	BCLKp High Time	266	1.69	1.88	2.06	ns	Figure 2-1	4
T _{low}	BCLKp Low Time	266	1.69	1.88	2.06	ns	Figure 2-1	4

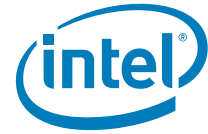

Table 2-10. System Bus Clock Differential HSTL AC Specifications (Sheet 2 of 2)

Symbol	Parameter	System Bus Clock (MHz)	Minimum	Typ	Maximum	Unit	Figure	Notes
T_{rise}	BCLKp Rise Time ⁷	All	333	500	667	ps	Figure 2-1	20–80%
T_{fall}	BCLKp Fall Time ⁷	All	333	500	667	ps	Figure 2-1	20–80%
V_{pp}	Minimum Input Swing	All		600		mV	Figure 2-1	⁶

Notes:

1. The system clock skew is ± 100 ps.
2. Measured on cross-point of rising edge of BCLKp and falling edge of BCLKn. Long-term jitter is defined as peak-to-peak variation measured by accumulating a large number of clock cycles and recording peak-to-peak jitter.
3. Cycle-to-cycle jitter is defined as peak-to-peak variation measured over 10,000 cycles peak-to-peak jitter.
4. Measured on cross point of rising edge of BCLKp and falling edge of BCLKn.
5. The system clock skew is ± 60 ps.
6. V_{ppmin} is defined as the minimum input differential voltage which will cause no increase in the clock receiver timing.
7. The measurement is taken at 40-60% of the signal and extrapolated to 20-80%.

Table 2-11. SMBus AC Specifications

Symbol	Parameter	Minimum	Maximum	Unit	Notes
f_{SMSC}	SMSC Clock Frequency		100	kHz	
T_{SMSC}	SMSC Clock Period	10		μ s	
t_{high}	SMSC Clock High Time	4.0		μ s	¹
t_{low}	SMSC Clock Low Time	4.7		μ s	¹
t_{rise}	SMSC Clock Rise Time		1.0	μ s	¹
t_{fall}	SMSC Clock Fall Time		0.3	μ s	¹
t_{VALID}	SMBus Output Valid Delay		1.0	μ s	
t_{SU}	SMBus Input Setup Time	250		ns	
t_{HLD}	SMBus Input Hold Time	0		ns	
t_{FREE}	Bus Free Time	4.7		μ s	²

Notes:

1. Please refer to Figure 2-2 for the Standard Microsystems Corporation (SMSC)* clock waveform.
2. Bus Free Time is the minimum time allowed between request cycles.

Figure 2-1. Generic Clock Waveform

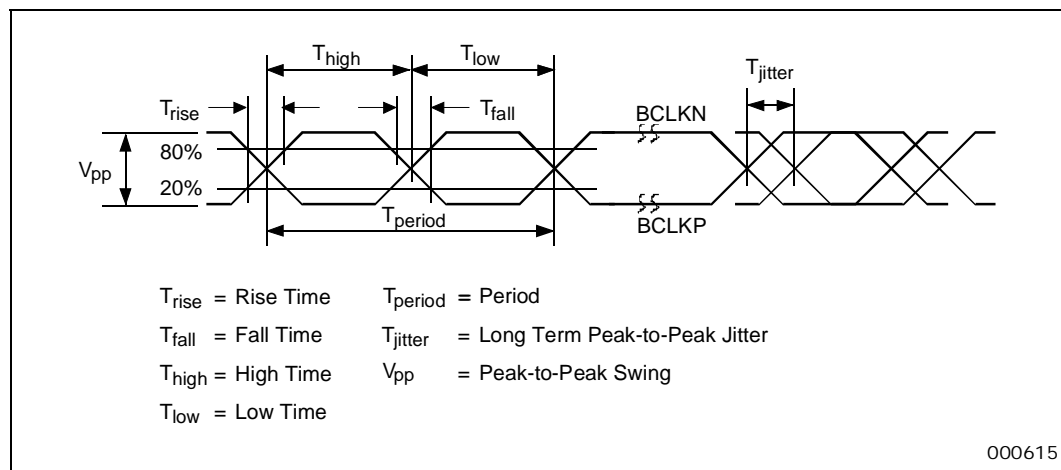

000615

Figure 2-2. SMSC Clock Waveform

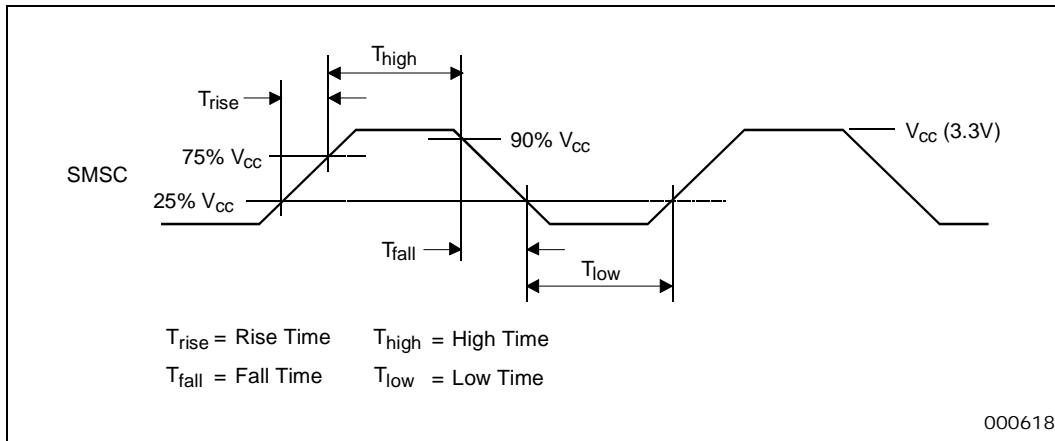

2.4.1 Maximum Ratings

Table 2-12 contains the processor stress ratings. Functional operation at the absolute maximum and minimum is neither implied nor guaranteed. The processor should not receive a clock while subjected to these conditions. Functional operating conditions are given in the DC tables. Extended exposure to the maximum ratings may affect device reliability. Furthermore, although the processor contains protective circuitry to resist damage from static electric discharge, one should always take precautions to avoid static voltages or electric fields.

Table 2-12. Dual-Core Intel® Itanium® Processor Absolute Maximum Ratings

Symbol	Parameter	Minimum	Maximum	Unit	Notes
$T_{storage}$	Processor Storage Temperature	-10	45	°C	1
$T_{shipping}$	Processor Shipping Temperature	-45	75	°C	2
V_{core}	Any V_{core} Voltage with Respect to GND	-0.3	1.55	V	
V_{cache}	Any V_{cache} Voltage with Respect to GND	-0.3	1.55	V	
V_{fixed}	Any V_{fixed} Voltage with Respect to GND	-0.3	1.55	V	
3.3V	Any 3.3 V Supply Voltage with Respect to GND	-0.3	5.5	V	3
$V_{in, SMBus}$	SMBus Buffer DC Input Voltage with Respect to GND	-0.1	6.0	V	3
$V_{in, AGTL+}$	AGTL+ Buffer DC Input Voltage with Respect to GND	-0.45	1.65	V	4, 5
V_{CTERM}	Any V_{CTERM} Voltage with Respect to GND	-0.45	1.65	V	
$V_{in, TAP}$	TAP Buffer DC Input Voltage with Respect to GND.	-0.45	1.65	V	4

Notes:

1. Storage temperature is temperature in which the processor can be stored for up to one year.
2. Shipping temperature is temperature in which the processor can be shipped for up to 24 hours.
3. Parameters are from third-party vendor specifications.
4. Maximum instantaneous voltage at receiver buffer input.
5. Specification includes $V_{in, AGTL+}$ and $V_{in, AGTL+ ASYNCHRONOUS}$ (AGTL+ asynchronous buffer DC input voltage with respect to GND).

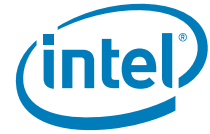

2.5 System Bus Signal Quality Specifications and Measurement Guidelines

Overshoot (or undershoot) is the absolute value of the maximum voltage above the nominal V_{CTERM} voltage (or below GND), as shown in Table 2-3. The overshoot/undershoot specifications limit transitions beyond V_{CTERM} or GND due to the fast signal edge rates. The processor can be permanently damaged by repeated overshoot or undershoot events on any input, output, or I/O buffer if the charge is large enough (that is, if the overshoot/undershoot is great enough). Determining the impact of an overshoot/undershoot condition requires knowledge of the magnitude, the pulse duration, and the activity factor (AF).

2.5.1 Overshoot/Undershoot Magnitude

Magnitude describes the maximum potential difference between a signal and its voltage reference level. For the processor, both are referenced to GND, as shown in Figure 2-3. It is important to note that overshoot and undershoot conditions are separate and their impact must be determined independently. Overshoot/undershoot magnitude levels must observe the absolute maximum specifications listed in Table 2-13 through Table 2-17. These specifications must not be violated at any time, regardless of bus activity or system state. Within these specifications are threshold levels that define different allowed pulse duration. Provided that the magnitude of the overshoot/undershoot is within the absolute maximum specifications, the pulse magnitude, duration, and activity factors must all be used to determine if the overshoot/undershoot pulse is within specifications.

Figure 2-3. System Bus Signal Waveform Exhibiting Overshoot/Undershoot

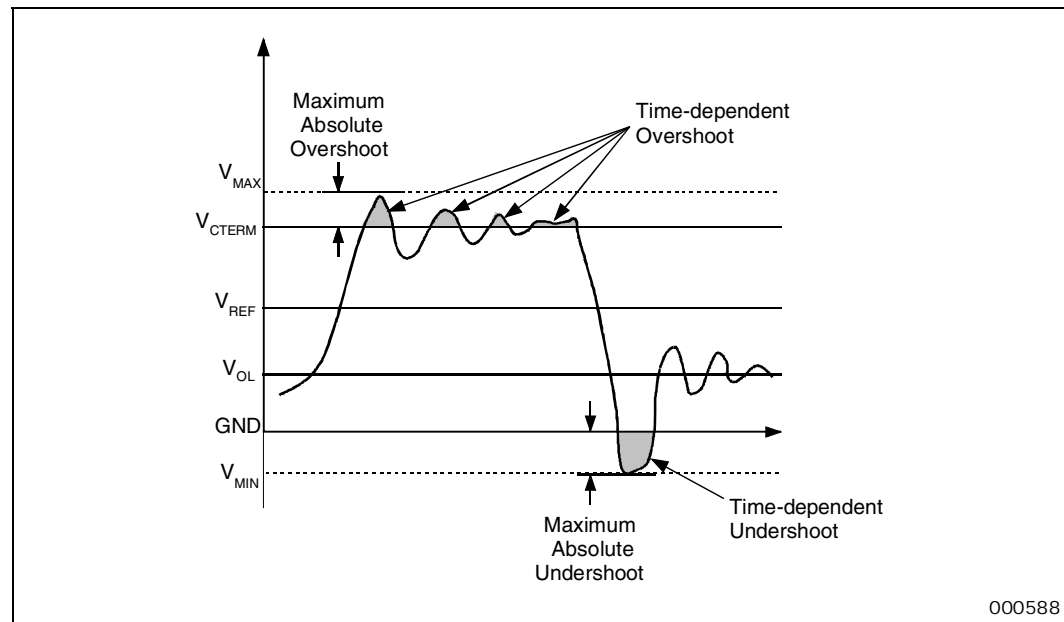

2.5.2 Overshoot/Undershoot Pulse Duration

Pulse duration describes the total time that an overshoot/undershoot event exceeds the overshoot/undershoot reference voltage (V_{CTERM}/GND). The total time could encompass several oscillations above the reference voltage. Multiple overshoot/undershoot pulses within a single overshoot/undershoot event may need to be measured to determine the total pulse duration.

Note: Oscillations below the reference voltage cannot be subtracted from the total overshoot/undershoot pulse duration.

2.5.3 Activity Factor

Activity factor (AF) describes the frequency of overshoot (or undershoot) occurrence relative to a clock. Since the highest frequency of assertion of any common clock signal is every other clock, an AF = 1 indicates that the specific overshoot (or undershoot) waveform occurs every other clock cycle. Thus, an AF = 0.01 indicates that the specific overshoot (or undershoot) waveform occurs one time in every 200 clock cycles. For source synchronous signals (data, and associated strobes), the activity factor is in reference to the strobe edge. The highest frequency of assertion of any source synchronous signal is every active edge of its associated strobe. So, an AF = 1 indicates that the specific overshoot (or undershoot) waveform occurs every other strobe cycle. The specifications provided in [Table 2-14](#) through [Table 2-17](#) show the maximum pulse duration allowed for a given overshoot/undershoot magnitude at a specific activity factor. Each table entry is independent of all others, meaning that the pulse duration reflects the existence of overshoot/undershoot events of that magnitude ONLY. A platform with an overshoot/undershoot that just meets the pulse duration for a specific magnitude where the AF < 1, means that there can be no other overshoot/undershoot events, even of lesser magnitude (if AF = 1, then the event occurs at all times and no other events can occur).

Note: AF for the common clock AGTL+ signals is referenced to BCLKn, and BCLKp frequency. The wired-OR Signals (BINIT#, HIT#, HITM#, BNR#, TND#, BERR#) are common clock AGTL+ signals.

Note: AF for source synchronous (2x) signals is referenced to STBP#[7:0], and STBN#[7:0].

2.5.4 Reading Overshoot/Undershoot Specification Tables

The overshoot/undershoot specification for the processor is not a simple single value. Instead, many factors are needed in order to correctly interpret the overshoot/undershoot specification. In addition to the magnitude of the overshoot, the following parameters must also be known: the width of the overshoot and the AF. To determine the allowed overshoot for a particular overshoot event, the following must be done:

1. Determine the *signal group* that the particular signal falls into. For AGTL+ signals operating in the 2x source synchronous domain, use [Table 2-14](#) through [Table 2-16](#). If the signal is a wired-OR AGTL+ signal operating in the common clock domain, use [Table 2-15](#) through [Table 2-17](#).
2. Determine the *magnitude* of the overshoot, or the undershoot (relative to GND).
3. Determine the *activity factor* (how often does this overshoot occur?).
4. Next, from the appropriate specification table, determine the *maximum pulse duration* (in nanoseconds) allowed. The pulse duration shown in the table refers to the period where either the maximum overshoot (for high phase) and undershoot (for low phase) occurred.

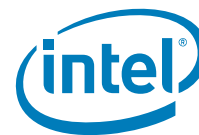

- Compare the specified maximum pulse duration to the signal being measured. If the pulse duration measured is less than the pulse duration shown in the table, then the signal meets the specifications.
- Undershoot events must be analyzed separately from overshoot events, as they are mutually exclusive.

2.5.5 Determining if a System Meets the Overshoot/Undershoot Specifications

The overshoot/undershoot specifications listed in [Table 2-13](#) through [Table 2-17](#) specify the allowable overshoot/undershoot for a single overshoot/undershoot event. However, most systems will have multiple overshoot and/or undershoot events that each has their own set of parameters (duration, AF and magnitude). While each overshoot on its own may meet the overshoot specification, the total impact of all overshoot events may cause the system to fail. A guideline to ensure a system passes the overshoot and undershoot specifications is shown below:

- Ensure that no signal ever exceeds V_{CTERM} or GND.
- If only one overshoot/undershoot event magnitude occurs, ensure that it meets the specifications listed in [Table 2-13](#) through [Table 2-17](#).
- If multiple overshoots and/or multiple undershoots occur, measure the worst-case pulse duration for each magnitude and compare the results against the $AF = 1$ specifications. If all of these worst-case overshoot or undershoot events meet the specifications (measured time < specifications) in the table (where $AF = 1$), then the system passes.

2.5.6 Wired-OR Signals

To ensure platform compatibility between the processors, system bus signals must meet certain overshoot and undershoot requirements. The system bus wired-OR signals (BINIT#, HIT#, HITM#, BNR#, TND#, BERR#) have the same absolute overshoot and undershoot specification as the Source Synchronous AGTL+ Signals, but they have different time-dependent overshoot/undershoot requirements.

Table 2-13. Source Synchronous AGTL+ Signal Group and Wired-OR Signal Group Absolute Overshoot/Undershoot Tolerance

Parameter	Description	Specification	Units
V_{CTERM}	I/O power supply voltage (nominal).	1.20	V
V_{MAX}	Maximum absolute voltage for system bus signals at the input of the receiver buffers.	1.65	V
V_{MIN}	Minimum absolute voltage for system bus signals at the input of the receiver buffers.	-0.45	V
Overshoot	Time dependent overshoot amount above V_{CTERM} .	1	
Undershoot	Time dependent undershoot amount below GND.	1	

Notes:

- These parameters cannot be specified in absolute terms.

Notes: The following notes apply to [Table 2-14](#) through [Table 2-17](#):

- Absolute Maximum Overshoot magnitude of 1.65 V must never be exceeded.
- Absolute Maximum Overshoot is measured referenced to GND. Pulse duration of overshoot is measured relative to V_{CTERM} .
- Absolute Maximum Undershoot and Pulse Duration of undershoot is measured relative to GND.
- Ringback below V_{CTERM} cannot be subtracted from overshoots/undershoots.
- Lesser undershoot does not allocate overshoot with longer duration or greater magnitude.
- All values specified by design characterization.



Table 2-14. Source Synchronous AGTL+ Signal Group Time-Dependent Overshoot/Undershoot Tolerance for 400-MHz System Bus

Absolute Maximum (V)		Pulse Duration (ns)						
Over-shoot	Under-shoot	AF = 1 ¹	AF = 0.75	AF = 0.5	AF = 0.25	AF = 0.1	AF = 0.05	AF = 0.01
1.65	-0.45	0.0035	0.0036	0.0037	0.0040	0.0121	0.0241	0.1207
1.6	-0.4	0.0039	0.0040	0.0045	0.0157	0.0396	0.0799	0.3996
1.55	-0.35	0.0124	0.0168	0.0255	0.0520	0.1309	0.2626	1.3107
1.5	-0.3	0.0405	0.0546	0.0833	0.1682	0.4279	0.8546	2.5
1.45	-0.25	0.1304	0.1755	0.2671	0.5438	1.3629	2.5	2.5
1.4	-0.2	0.4136	0.5581	0.8524	1.7215	2.5	2.5	2.5
1.35	-0.15	1.3163	1.7815	2.5	2.5	2.5	2.5	2.5
1.3	-0.1	2.5	2.5	2.5	2.5	2.5	2.5	2.5
1.25	-0.05	2.5	2.5	2.5	2.5	2.5	2.5	2.5

Notes:

1. Activity Factor = 1 means signal toggles every 5 ns.

Table 2-15. Wired-OR Signal Group (BINIT#, HIT#, HITM#, BNR#, TND#, BERR#) Overshoot/Undershoot Tolerance for 400-MHz System Bus

Absolute Maximum (V)		Pulse Duration (ns)						
Over-shoot	Under-shoot	AF = 1 ¹	AF = 0.75	AF = 0.5	AF = 0.25	AF = 0.1	AF = 0.05	AF = 0.01
1.65	-0.45	0.0166	0.0192	0.0306	0.0614	0.1539	0.3067	1.5374
1.6	-0.4	0.0506	0.0674	0.1017	0.2032	0.5090	1.0213	5
1.55	-0.35	0.1659	0.2216	0.3342	0.6676	1.6734	3.3413	5
1.5	-0.3	0.5413	0.7218	1.0840	2.1814	5	5	5
1.45	-0.25	1.7343	2.3194	3.4995	5	5	5	5
1.4	-0.2	5	5	5	5	5	5	5
1.35	-0.15	5	5	5	5	5	5	5

Notes:

1. Activity Factor = 1 means signal toggles every 10 ns.

Table 2-16. Source Synchronous AGTL+ Signal Group Time-Dependent Overshoot/Undershoot Tolerance for 533-MHz System Bus (Sheet 1 of 2)

Absolute Maximum (V)		Pulse Duration (ns)						
Over-shoot	Under-shoot	AF = 1 ¹	AF = 0.75	AF = 0.5	AF = 0.25	AF = 0.1	AF = 0.05	AF = 0.01
1.65	-0.45	0.0026	0.0027	0.0028	0.0030	0.0091	0.0181	0.0902
1.6	-0.4	0.0029	0.0030	0.0034	0.0118	0.0297	0.0600	0.2989
1.55	-0.35	0.0093	0.0126	0.0191	0.0387	0.0980	0.1963	0.9822
1.5	-0.3	0.0303	0.0409	0.0625	0.1268	0.3178	0.6406	1.875
1.45	-0.25	0.3095	0.4191	0.6366	1.2965	1.875	1.875	1.875

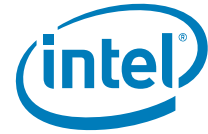

Table 2-16. Source Synchronous AGTL+ Signal Group Time-Dependent Overshoot/Undershoot Tolerance for 533-MHz System Bus (Sheet 2 of 2)

Absolute Maximum (V)		Pulse Duration (ns)						
1.4	-0.2	0.9925	1.3358	1.875	1.875	1.875	1.875	1.875
1.35	-0.15	1.875	1.875	1.875	1.875	1.875	1.875	1.875
1.3	-0.10	1.875	1.875	1.875	1.875	1.875	1.875	1.875

Notes:

- 1. Activity Factor = 1 means signal toggles every 3.75 ns.

Table 2-17. Wired-OR Signal Group (BINIT#, HIT#, HITM#, BNR#, TND#, BERR#) Overshoot/Undershoot Tolerance for 533-MHz System Bus

Absolute Maximum (V)		Pulse Duration (ns)						
Over-shoot	Under-shoot	AF = 1 ¹	AF = 0.75	AF = 0.5	AF = 0.25	AF = 0.1	AF = 0.05	AF = 0.01
1.65	-0.45	0.01248	0.0144	0.0230	0.0461	0.1155	0.2301	1.1530
1.6	-0.4	0.0380	0.0507	0.0763	0.1522	0.3814	0.7627	3.75
1.55	-0.35	0.1250	0.1668	0.2507	0.5004	1.2537	2.5059	3.75
1.5	-0.3	0.4054	0.5424	0.8163	1.6302	3.75	3.75	3.75
1.45	-0.25	1.3013	1.7396	2.6246	3.75	3.75	3.75	3.75
1.4	-0.2	3.75	3.75	3.75	3.75	3.75	3.75	3.75
1.35	-0.15	3.75	3.75	3.75	3.75	3.75	3.75	3.75

Notes:

- 1. Activity Factor = 1 means signal toggles every 7.5 ns.

2.6 Voltage Regulator Connector Signals

The VR module consists of three DC-DC converters, V_{core} , V_{cache} , and V_{fixed} .

Table 2-18 lists all of the signals which are part of the processor package VR output connector.

Table 2-18. VR Connector Signals

Group Name	Signals
Voltage Regulator Connector	PPODGD#, CPUPRES#, GND, Vid_valid, Vid_Core[5:0], Vid_cache [5:0], Vcache_sense, Gnd_sense, Vcore_sense, Vfixed_sense, OUTEN.

Warning:

If the VR cannot supply the voltages requested by the components in the processor package, then it must disable itself.

Figure 2-4 shows the top view of the processor package power tab. See Table 2-19 for power tab connector signals.

Figure 2-4. Processors Power Tab Physical Layout

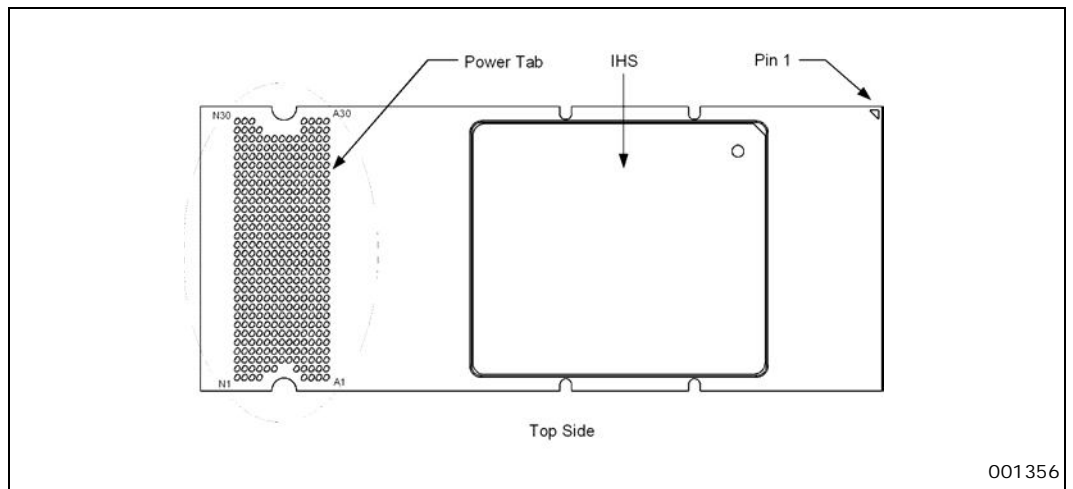

Table 2-19. Power Connector Pinouts (Sheet 1 of 2)

Power Tab VR Pads	Description
A1 - C1	GND
L1 - N1	GND
A2	PPODGD#
B2	CPUPRES#
D1, K1, C2, D2, E2	Vfixed
H2 - N2	Vfixed
A3	Vid_valid
B3	Vid_core [0]
C3	Vid_core [1]
D3	Vid_core [2]
E3	Vid_core [3]
F3	Vid_core [4]
G3	Vid_core [5]
H3	Vid_cache [0]
J3	Vid_cache [1]
K3	Vid_cache [2]
L3	Vid_cache [3]
M3	Vid_cache [4]
N3	Vid_cache [5]
A4 - N4	GND
A5 - N5	Vcache
A6 - N6	GND
A7 - N7	Vcore
A8 - N8	GND
A9 - N9	Vcore

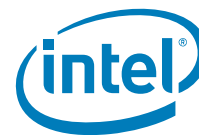

Table 2-19. Power Connector Pinouts (Sheet 2 of 2)

Power Tab VR Pads	Description
A10 - N10	GND
A11 - N11	Vcore
A12 - N12	GND
A13 - N13	Vcore
A14 - N14	GND
A15 - N15	Vcore
A16 - N16	GND
A17 - N17	Vcore
A18 - N18	GND
A19 - N19	Vcore
A20 - N20	GND
A21 - N21	Vcore
A22 - N22	GND
A23 - N23	Vcore
A24 - N24	GND
A25 - N25	Vcore
A26 - N26	GND
A27 - N27	Vcache
A28 - N28	GND
A29	Vcache_sense
B29	Gnd_sense
C29	Vcore_sense
D29	Vfixed_sense
K29	GND
L29	Reserved
M29	Reserved
N29	OUTEN
A30 - D30	GND
L30 - N30	GND

The VR shall provide a selectable output voltage controlled via multiple binary weighted Voltage Identification (VID) inputs. The VID value (high = 1; low = 0) is defined in [Table 2-20](#). VID pins will be controlled by the processor.



Table 2-20. Processors Core Voltage Identification Code (V_{CORE} and V_{CACHE})

Processor Pins (0 = low, 1 = high)													
400	200	100	50	25	12.5	(mV)	400	200	100	50	25	12.5	(mV)
VID 5	VID 4	VID 3	VID 2	VID 1	VID 0	Vout (V)	VID 5	VID 4	VID 3	VID 2	VID 1	VID 0	Vout (V)
1	1	1	1	1	1	OFF	0	1	1	1	1	1	0.9125
1	1	1	1	1	0	1.3	0	1	1	1	1	0	0.9
1	1	1	1	0	1	1.2875	0	1	1	1	0	1	0.8875
1	1	1	1	0	0	1.275	0	1	1	1	0	0	0.875
1	1	1	0	1	1	1.2625	0	1	1	0	1	1	0.8625
1	1	1	0	1	0	1.25	0	1	1	0	1	0	0.85
1	1	1	0	0	1	1.2375	0	1	1	0	0	1	0.8375
1	1	1	0	0	0	1.225	0	1	1	0	0	0	0.825
1	1	0	1	1	1	1.2125	0	1	0	1	1	1	0.8125
1	1	0	1	1	0	1.2	0	1	0	1	1	0	0.8
1	1	0	1	0	1	1.1875	0	1	0	1	0	1	0.7875
1	1	0	1	0	0	1.175	0	1	0	1	0	0	0.775
1	1	0	0	1	1	1.1625	0	1	0	0	1	1	0.7625
1	1	0	0	1	0	1.15	0	1	0	0	1	0	0.75
1	1	0	0	0	1	1.1375	0	1	0	0	0	1	0.7375
1	1	0	0	0	0	1.125	0	1	0	0	0	0	0.725
1	0	1	1	1	1	1.1125	0	0	1	1	1	1	0.7125
1	0	1	1	1	0	1.1	0	0	1	1	1	0	0.7
1	0	1	1	0	1	1.0875	0	0	1	1	0	1	0.6875
1	0	1	1	0	0	1.075	0	0	1	1	0	0	0.675
1	0	1	0	1	1	1.0625	0	0	1	0	1	1	0.6625
1	0	1	0	1	0	1.05	0	0	1	0	1	0	0.65
1	0	1	0	0	1	1.0375	0	0	1	0	0	1	0.6375
1	0	1	0	0	0	1.025	0	0	1	0	0	0	0.625
1	0	0	1	1	1	1.0125	0	0	0	1	1	1	0.6125
1	0	0	1	1	0	1	0	0	0	1	1	0	0.6
1	0	0	1	0	1	0.9875	0	0	0	1	0	1	0.5875
1	0	0	1	0	0	0.975	0	0	0	1	0	0	0.575
1	0	0	0	1	1	0.9625	0	0	0	0	1	1	0.5625
1	0	0	0	1	0	0.95	0	0	0	0	1	0	0.55
1	0	0	0	0	1	0.9375	0	0	0	0	0	1	0.5375
1	0	0	0	0	0	0.925	0	0	0	0	0	0	0.525

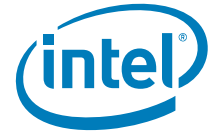

2.7 System Bus Clock and Processor Clocking

The BCLKn and BCLKp inputs control the operating frequency of the processor system bus interface. All processor system bus timing parameters are specified with respect to the falling edge of BCLKn and rising edge of BCLKp. The address pins A[21:17]# will be used to specify the system bus frequency during reset. The processor will ensure that the correct bus/core ratio is elected based on the bus frequency that is specified during reset.

Cold Reset Sequence:

- The configuration pins (A[21:17]#) must be asserted the entire time RESET# is asserted.
- RESET# must be asserted before PWRGOOD is asserted.
- The duration from the assertion of PWRGOOD to the deassertion of RESET# must be 1 millisecond minimum.
- After RESET# is deasserted, all the configuration, including pins A[21:17]#, must remain valid for 2 BCLKs (minimum) to 3 BCLKs (maximum).
- BCLK is shown as a time reference to the BCLK period. It is not a requirement that this is BCLKn or BCLKp signal.
- Configuration signals other than A[21:17]# must be asserted 4 BCLKs prior to the deasserted edge of RESET# and must remain valid for 2 BCLKs (minimum) to 3 BCLKs (maximum) after the deasserted edge of RESET#.

Figure 2-5 outlines the timing relationship between the configuration pins, RESET# and PWRGOOD for cold reset.

Figure 2-5. System Bus Reset and Configuration Timings for Cold Reset

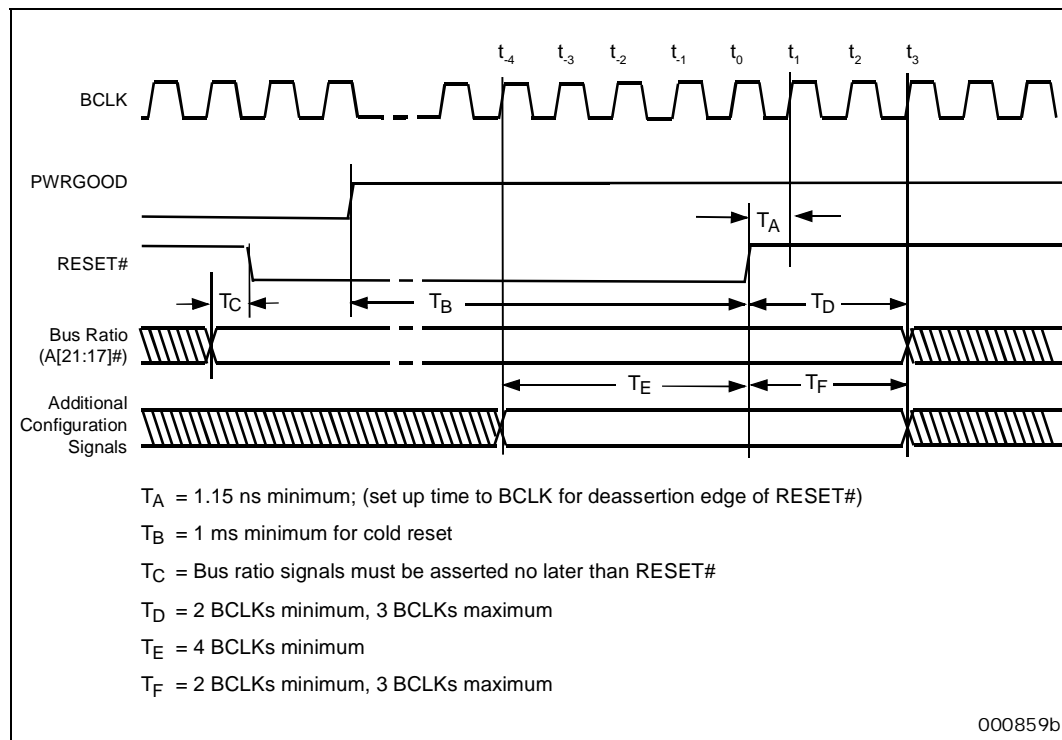

Warm Reset Sequence:

- PWRGOOD remains high throughout the entire sequence, as power is already available and stable to the processor.
- The configuration pins (A[21:17]#) must be asserted the entire time RESET# is asserted.
- The duration from the assertion of RESET# to the deassertion of RESET# must be 1 millisecond minimum.
- After RESET# is deasserted, the configuration pins must remain valid for two BCLKs (minimum) to three BCLKs (maximum).
- BCLK is shown as a time reference to the BCLK period. It is not a requirement that this is BCLKn or BCLKp signal.
- Configuration signals other than A[21:17]# must be asserted four BCLKs prior to the deasserted edge of RESET# and must remain valid for two BCLKs (minimum) to three BCLKs (maximum) after the deasserted edge of RESET#.

Figure 2-6 outlines the timing relationship between the configuration pins, RESET# and PWRGOOD for warm reset.

Figure 2-6. System Bus Reset and Configuration Timings for Warm Reset

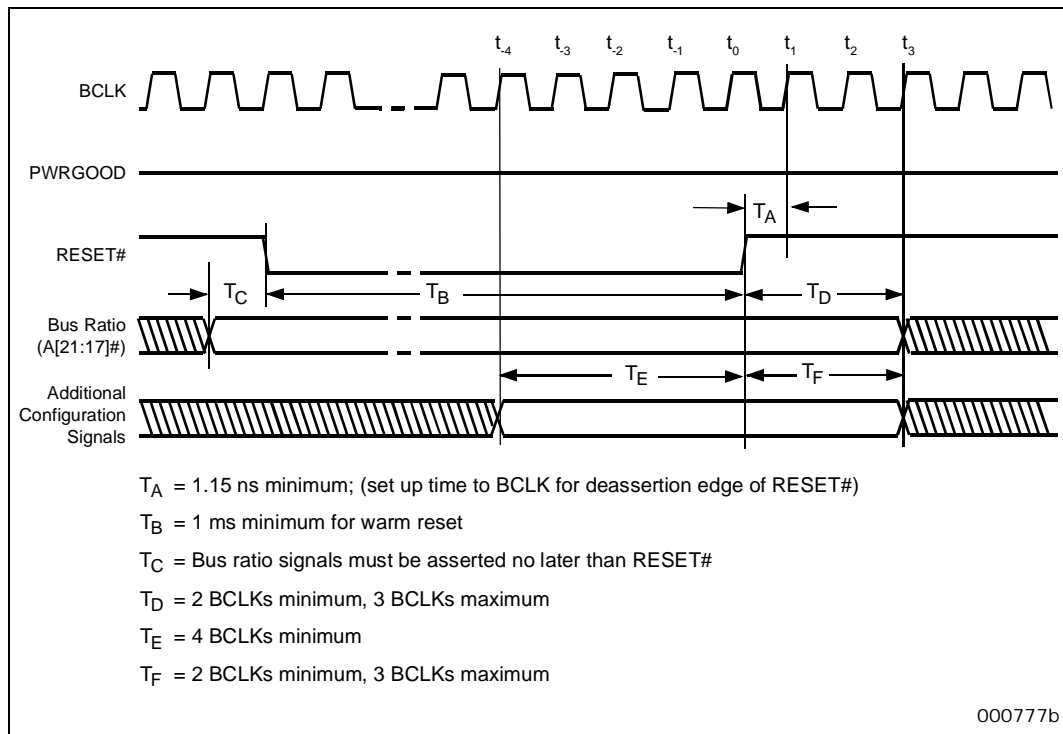

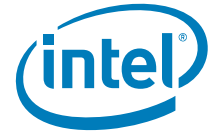

2.8 Recommended Connections for Unused Pins

Pins that are unused in an application environment (as opposed to testing environment) should be connected to the states listed in [Table 2-21](#). Pins that must be used in an application are stated as such and do not have a recommended state for unused connection.

Table 2-21. Connection for Unused Pins

Pins/Pin Groups	Recommended Connections	Notes
AGTL+ pins	H	1, 2
HSTL Clock Signals	Must be used	
All Power Signals	Must be used	
PWRGOOD	Must be used	
TAP Signals		
TCK	L	1, 3
TRST#	L	1, 3
TDI	H	1, 3
TDO	H	1, 3
TMS	H	1, 3
System Management Signals		
3.3V	GND	
SMA[2:0]	N/C	
SMSC	N/C	
SMSD	N/C	
SMWP	N/C	
THRMALERT#	H	1, 4
LVTTTL Power Pod Signals		
OUTEN	Must be used	
PPODGD#	Must be used	
PROCPRES#	Must be used	
Other Pins		
N/C	N/C	
A20M#	N/C	
IGNNE#	N/C	
LOCK#	N/C	
FERR#	N/C	
TUNER1	N/C or H	3,5
TUNER2	H	1
TUNER3	N/C or H	3,5

Notes:

1. L = GND, H = V_{CTERM} .
2. AGTL+ output signals SBSY[0:1]#, DBSY[0:1]#, and DRDY[0,1]# may be left as N/C if not used on platform.
3. Can be No-Connect or connected to V_{CTERM} via a 100ohm or 150 ohm resistor.
4. THRMALERT# should be pulled up to 3.3 V through a resistor.
5. With A[21;17] settings to all 0' or all 1's, please refer to [Table 2-22](#) for proper connection.



Table 2-22. TUNER1/TUNER3 Translation Table

A[21:17]# ¹	TUNER1 ²	TUNER3 ²	System Bus (MHz)	Slew Rate (V/ns)
0	0	0	667	1.7
0	0	1	533	1.4
0	1	N/A	400	0.8
1	0	0	667	1.92
1	0	1	533	1.7
1	1	N/A	400	0.82

Notes:

- 1. 0 = V_{CTERM}, 1 = GND
- 2. 0 = Resistor not present, 1 = Resistor present

§



Table 3-1 provides the Dual-Core Intel Itanium processor 9000 and 9100 series pin list in alphabetical order.

Table 3-2 provides the Dual-Core Intel Itanium processor 9000 and 9100 series pin list by pin location.

Table 3-1. Pin/Signal Information Sorted by Pin Name (Sheet 1 of 15)

Pin Name	System Bus Signal Name	Pin Location	Input/Output	Notes
3.3V		B02	IN	SMBus supply voltage
A003#	AA03#/EXF0#	V06	IN/OUT	
A004#	AA04#/EXF1#	V02	IN/OUT	
A005#	AA05#/EXF2#	U03	IN/OUT	
A006#	AA06#/EXF3#	W03	IN/OUT	
A007#	AA07#/EXF4#	Y02	IN/OUT	
A008#	AA08#/BE0#	Y06	IN/OUT	
A009#	AA09#/BE1#	U07	IN/OUT	
A010#	AA10#/BE2#	V04	IN/OUT	
A011#	AA11#/BE3#	AA05	IN/OUT	
A012#	AA12#/BE4#	W05	IN/OUT	
A013#	AA13#/BE5#	Y04	IN/OUT	
A014#	AA14#/BE6#	W07	IN/OUT	
A015#	AA15#/BE7#	V08	IN/OUT	
A016#	AA16#/DID0#	U13	IN/OUT	
A017#	AA17#/DID1#	Y08	IN/OUT	
A018#	AA18#/DID2#	U09	IN/OUT	
A019#	AA19#/DID3#	V12	IN/OUT	
A020#	AA20#/DID4#	V10	IN/OUT	
A021#	AA21#/DID5#	W09	IN/OUT	
A022#	AA22#/DID6#	W13	IN/OUT	
A023#	AA23#/DID7#	AA11	IN/OUT	
A024#	AA24#/DID8#	Y10	IN/OUT	
A025#	AA25#/DID9#	Y12	IN/OUT	
A026#	AA26#/AB26#	W11	IN/OUT	
A027#	AA27#/xTPRValue0#	U19	IN/OUT	
A028#	AA28#/xTPRValue1#	U15	IN/OUT	
A029#	AA29#/xTPRValue2#	V18	IN/OUT	
A030#	AA30#/xTPRValue3#	W19	IN/OUT	
A031#	AA31#/xTPRDisable#	V14	IN/OUT	
A032#	AA32#/ATTR0#	W17	IN/OUT	
A033#	AA33#/ATTR1#	AA17	IN/OUT	
A034#	AA34#/ATTR2#	Y14	IN/OUT	
A035#	AA35#/ATTR3#	Y18	IN/OUT	
A036#	AA36#/AB36#	Y16	IN/OUT	
A037#	AA37#/AB37#	W15	IN/OUT	
A038#	AA38#/AB38#	V16	IN/OUT	
A039#	AA39#/AB39#	Y20	IN/OUT	
A040#	AA40#/AB40#	V24	IN/OUT	

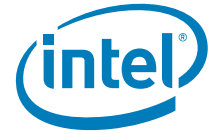

Table 3-1. Pin/Signal Information Sorted by Pin Name (Sheet 2 of 15)

Pin Name	System Bus Signal Name	Pin Location	Input/Output	Notes
A041#	AA41#/AB41#	W25	IN/OUT	
A042#	AA42#/AB42#	U23	IN/OUT	
A043#	AA43#/AB43#	Y24	IN/OUT	
A044#	AA44#/AB44#	W21	IN/OUT	
A045#	AA45#/AB45#	V20	IN/OUT	
A046#	AA46#/AB46#	W23	IN/OUT	
A047#	AA47#/AB47#	V22	IN/OUT	
A048#	AA48#/AB48#	U21	IN/OUT	
A049#	AA49#/AB49#	Y22	IN/OUT	
A20M#	A20M#	AH23	N/C	
ADS#	ADS#	AB20	IN/OUT	
AP0#	AP0#	AA25	IN/OUT	
AP1#	AP1#	AA23	IN/OUT	
BCLKn	BCLKN	AH13	IN	
BCLKp	BCLK	AG13	IN	
BERR#	BERR#	AB22	IN/OUT	
BINIT#	BINIT#	AA15	IN/OUT	
BNR#	BNR#	U17	IN/OUT	
BPM0#	BPM0#	AD22	IN/OUT	
BPM1#	BPM1#	AC25	IN/OUT	
BPM2#	BPM2#	AE23	IN/OUT	
BPM3#	BPM3#	AC23	IN/OUT	
BPM4#	BPM4#	AD24	IN/OUT	
BPM5#	BPM5#	AB24	IN/OUT	
BPRI#	BPRI#	AE19	IN	
BR0#	BREQ0#	AF16	IN/OUT	
BR1#	BREQ1#	AD16	IN	
BR2#	BREQ2#	AB18	IN	
BR3#	BREQ3#	AF18	IN	
CPUPRES#	CPUPRES#	AG15	OUT	Power pod signal
D000#	D00#	C07	IN/OUT	
D001#	D01#	E03	IN/OUT	
D002#	D02#	C05	IN/OUT	
D003#	D03#	D04	IN/OUT	
D004#	D04#	D02	IN/OUT	
D005#	D05#	D06	IN/OUT	
D006#	D06#	F06	IN/OUT	
D007#	D07#	F02	IN/OUT	
D008#	D08#	G05	IN/OUT	
D009#	D09#	H06	IN/OUT	
D010#	D10#	E07	IN/OUT	
D011#	D11#	H02	IN/OUT	
D012#	D12#	H04	IN/OUT	
D013#	D13#	J03	IN/OUT	



Table 3-1. Pin/Signal Information Sorted by Pin Name (Sheet 3 of 15)

Pin Name	System Bus Signal Name	Pin Location	Input/Output	Notes
D014#	D14#	G03	IN/OUT	
D015#	D15#	G07	IN/OUT	
D016#	D16#	K04	IN/OUT	
D017#	D17#	L03	IN/OUT	
D018#	D18#	K06	IN/OUT	
D019#	D19#	L05	IN/OUT	
D020#	D20#	M02	IN/OUT	
D021#	D21#	L07	IN/OUT	
D022#	D22#	N07	IN/OUT	
D023#	D23#	N03	IN/OUT	
D024#	D24#	P04	IN/OUT	
D025#	D25#	R03	IN/OUT	
D026#	D26#	P06	IN/OUT	
D027#	D27#	P02	IN/OUT	
D028#	D28#	M06	IN/OUT	
D029#	D29#	R05	IN/OUT	
D030#	D30#	T02	IN/OUT	
D031#	D31#	R07	IN/OUT	
D032#	D32#	H10	IN/OUT	
D033#	D33#	C11	IN/OUT	
D034#	D34#	D10	IN/OUT	
D035#	D35#	C09	IN/OUT	
D036#	D36#	D12	IN/OUT	
D037#	D37#	D08	IN/OUT	
D038#	D38#	G09	IN/OUT	
D039#	D39#	E13	IN/OUT	
D040#	D40#	E09	IN/OUT	
D041#	D41#	G11	IN/OUT	
D042#	D42#	H08	IN/OUT	
D043#	D43#	G13	IN/OUT	
D044#	D44#	F12	IN/OUT	
D045#	D45#	F08	IN/OUT	
D046#	D46#	H12	IN/OUT	
D047#	D47#	J13	IN/OUT	
D048#	D48#	M08	IN/OUT	
D049#	D49#	K08	IN/OUT	
D050#	D50#	K10	IN/OUT	
D051#	D51#	M12	IN/OUT	
D052#	D52#	L13	IN/OUT	
D053#	D53#	L09	IN/OUT	
D054#	D54#	P08	IN/OUT	
D055#	D55#	N13	IN/OUT	
D056#	D56#	L11	IN/OUT	
D057#	D57#	P12	IN/OUT	



Table 3-1. Pin/Signal Information Sorted by Pin Name (Sheet 4 of 15)

Pin Name	System Bus Signal Name	Pin Location	Input/Output	Notes
D058#	D58#	N09	IN/OUT	
D059#	D59#	R13	IN/OUT	
D060#	D60#	R11	IN/OUT	
D061#	D61#	P10	IN/OUT	
D062#	D62#	T12	IN/OUT	
D063#	D63#	R09	IN/OUT	
D064#	D64#	D18	IN/OUT	
D065#	D65#	D14	IN/OUT	
D066#	D66#	D16	IN/OUT	
D067#	D67#	E15	IN/OUT	
D068#	D68#	F14	IN/OUT	
D069#	D69#	F18	IN/OUT	
D070#	D70#	C19	IN/OUT	
D071#	D71#	G15	IN/OUT	
D072#	D72#	G17	IN/OUT	
D073#	D73#	C17	IN/OUT	
D074#	D74#	E19	IN/OUT	
D075#	D75#	H14	IN/OUT	
D076#	D76#	H16	IN/OUT	
D077#	D77#	H18	IN/OUT	
D078#	D78#	J15	IN/OUT	
D079#	D79#	G19	IN/OUT	
D080#	D80#	K18	IN/OUT	
D081#	D81#	L15	IN/OUT	
D082#	D82#	L19	IN/OUT	
D083#	D83#	K16	IN/OUT	
D084#	D84#	M14	IN/OUT	
D085#	D85#	N19	IN/OUT	
D086#	D86#	M18	IN/OUT	
D087#	D87#	P14	IN/OUT	
D088#	D88#	L17	IN/OUT	
D089#	D89#	R17	IN/OUT	
D090#	D90#	R19	IN/OUT	
D091#	D91#	N15	IN/OUT	
D092#	D92#	R15	IN/OUT	
D093#	D93#	P16	IN/OUT	
D094#	D94#	T14	IN/OUT	
D095#	D95#	P18	IN/OUT	
D096#	D96#	E21	IN/OUT	
D097#	D97#	C23	IN/OUT	
D098#	D98#	D22	IN/OUT	
D099#	D99#	C21	IN/OUT	
D100#	D100#	E25	IN/OUT	
D101#	D101#	G21	IN/OUT	



Table 3-1. Pin/Signal Information Sorted by Pin Name (Sheet 5 of 15)

Pin Name	System Bus Signal Name	Pin Location	Input/Output	Notes
D102#	D102#	D20	IN/OUT	
D103#	D103#	F24	IN/OUT	
D104#	D104#	D24	IN/OUT	
D105#	D105#	H22	IN/OUT	
D106#	D106#	F20	IN/OUT	
D107#	D107#	G25	IN/OUT	
D108#	D108#	G23	IN/OUT	
D109#	D109#	H24	IN/OUT	
D110#	D110#	J25	IN/OUT	
D111#	D111#	H20	IN/OUT	
D112#	D112#	L21	IN/OUT	
D113#	D113#	L25	IN/OUT	
D114#	D114#	K22	IN/OUT	
D115#	D115#	M24	IN/OUT	
D116#	D116#	L23	IN/OUT	
D117#	D117#	K20	IN/OUT	
D118#	D118#	M20	IN/OUT	
D119#	D119#	N25	IN/OUT	
D120#	D120#	P24	IN/OUT	
D121#	D121#	R25	IN/OUT	
D122#	D122#	P20	IN/OUT	
D123#	D123#	T24	IN/OUT	
D124#	D124#	R21	IN/OUT	
D125#	D125#	P22	IN/OUT	
D126#	D126#	R23	IN/OUT	
D127#	D127#	N21	IN/OUT	
DBSY#	DBSY#	AC09	IN/OUT	
DBSY0#	DBSY_C1#	AA09	OUT	
DBSY1#	DBSY_C2#	AA19	OUT	
DEFER#	DEFER#	AB14	IN	
DEP00#	DEP0#	J07	IN/OUT	
DEP01#	DEP1#	J05	IN/OUT	
DEP02#	DEP2#	T06	IN/OUT	
DEP03#	DEP3#	T04	IN/OUT	
DEP04#	DEP4#	J09	IN/OUT	
DEP05#	DEP5#	J11	IN/OUT	
DEP06#	DEP6#	T08	IN/OUT	
DEP07#	DEP7#	T10	IN/OUT	
DEP08#	DEP8#	J19	IN/OUT	
DEP09#	DEP9#	J17	IN/OUT	
DEP10#	DEP10#	T18	IN/OUT	
DEP11#	DEP11#	T16	IN/OUT	
DEP12#	DEP12#	J21	IN/OUT	
DEP13#	DEP13#	J23	IN/OUT	

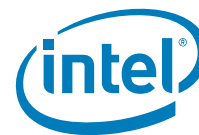

Table 3-1. Pin/Signal Information Sorted by Pin Name (Sheet 6 of 15)

Pin Name	System Bus Signal Name	Pin Location	Input/Output	Notes
DEP14#	DEP14#	T20	IN/OUT	
DEP15#	DEP15#	T22	IN/OUT	
DRDY#	DRDY#	AC11	IN/OUT	
DRDY0#	DRDY_C1#	AA07	OUT	
DRDY1#	DRDY_C2#	AA21	OUT	
FERR#	FERR#	AH25	OUT	
GND	GND	A01	IN	
GND	GND	A03	IN	
GND	GND	A05	IN	
GND	GND	A08	IN	
GND	GND	A13	IN	
GND	GND	A16	IN	
GND	GND	A19	IN	
GND	GND	A20	IN	
GND	GND	A23	IN	
GND	GND	A24	IN	
GND	GND	AA02	IN	
GND	GND	AA20	IN	
GND	GND	AA24	IN	
GND	GND	AB01	IN	
GND	GND	AB03	IN	
GND	GND	AB05	IN	
GND	GND	AB07	IN	
GND	GND	AB09	IN	
GND	GND	AB11	IN	
GND	GND	AB13	IN	
GND	GND	AB15	IN	
GND	GND	AB17	IN	
GND	GND	AB19	IN	
GND	GND	AB21	IN	
GND	GND	AB23	IN	
GND	GND	AB25	IN	
GND	GND	AC02	IN	
GND	GND	AC24	IN	
GND	GND	AD01	IN	
GND	GND	AD03	IN	
GND	GND	AD05	IN	
GND	GND	AD07	IN	
GND	GND	AD09	IN	
GND	GND	AD11	IN	
GND	GND	AD13	IN	
GND	GND	AD15	IN	
GND	GND	AD17	IN	
GND	GND	AD19	IN	



Table 3-1. Pin/Signal Information Sorted by Pin Name (Sheet 7 of 15)

Pin Name	System Bus Signal Name	Pin Location	Input/Output	Notes
GND	GND	AD21	IN	
GND	GND	AD23	IN	
GND	GND	AD25	IN	
GND	GND	AE02	IN	
GND	GND	AE24	IN	
GND	GND	AF01	IN	
GND	GND	AF05	IN	
GND	GND	AF07	IN	
GND	GND	AF09	IN	
GND	GND	AF11	IN	
GND	GND	AF13	IN	
GND	GND	AF15	IN	
GND	GND	AF17	IN	
GND	GND	AF19	IN	
GND	GND	AF21	IN	
GND	GND	AG02	IN	
GND	GND	AG04	IN	
GND	GND	AG06	IN	
GND	GND	AG08	IN	
GND	GND	AG10	IN	
GND	GND	AG12	IN	
GND	GND	AG14	IN	
GND	GND	AG16	IN	
GND	GND	AG18	IN	
GND	GND	AG20	IN	
GND	GND	AG22	IN	
GND	GND	AG24	IN	
GND	GND	AH01	IN	
GND	GND	B03	IN	
GND	GND	B05	IN	
GND	GND	B07	IN	
GND	GND	B09	IN	
GND	GND	B10	IN	
GND	GND	B11	IN	
GND	GND	B13	IN	
GND	GND	B15	IN	
GND	GND	B17	IN	
GND	GND	B19	IN	
GND	GND	B21	IN	
GND	GND	B23	IN	
GND	GND	B25	IN	
GND	GND	C02	IN	
GND	GND	C06	IN	
GND	GND	C10	IN	



Table 3-1. Pin/Signal Information Sorted by Pin Name (Sheet 8 of 15)

Pin Name	System Bus Signal Name	Pin Location	Input/Output	Notes
GND	GND	C14	IN	
GND	GND	C18	IN	
GND	GND	C22	IN	
GND	GND	D01	IN	
GND	GND	D03	IN	
GND	GND	D05	IN	
GND	GND	D07	IN	
GND	GND	D09	IN	
GND	GND	D11	IN	
GND	GND	D13	IN	
GND	GND	D15	IN	
GND	GND	D17	IN	
GND	GND	D19	IN	
GND	GND	D21	IN	
GND	GND	D23	IN	
GND	GND	D25	IN	
GND	GND	E04	IN	
GND	GND	E08	IN	
GND	GND	E12	IN	
GND	GND	E16	IN	
GND	GND	E20	IN	
GND	GND	E24	IN	
GND	GND	F01	IN	
GND	GND	F03	IN	
GND	GND	F05	IN	
GND	GND	F07	IN	
GND	GND	F09	IN	
GND	GND	F11	IN	
GND	GND	F13	IN	
GND	GND	F15	IN	
GND	GND	F17	IN	
GND	GND	F19	IN	
GND	GND	F21	IN	
GND	GND	F23	IN	
GND	GND	F25	IN	
GND	GND	G02	IN	
GND	GND	H03	IN	
GND	GND	H05	IN	
GND	GND	H07	IN	
GND	GND	H09	IN	
GND	GND	H11	IN	
GND	GND	H13	IN	
GND	GND	H15	IN	
GND	GND	H17	IN	



Table 3-1. Pin/Signal Information Sorted by Pin Name (Sheet 9 of 15)

Pin Name	System Bus Signal Name	Pin Location	Input/Output	Notes
GND	GND	H19	IN	
GND	GND	H21	IN	
GND	GND	H23	IN	
GND	GND	H25	IN	
GND	GND	J01	IN	
GND	GND	J04	IN	
GND	GND	J08	IN	
GND	GND	J12	IN	
GND	GND	J16	IN	
GND	GND	J20	IN	
GND	GND	J24	IN	
GND	GND	K03	IN	
GND	GND	K05	IN	
GND	GND	K07	IN	
GND	GND	K09	IN	
GND	GND	K11	IN	
GND	GND	K13	IN	
GND	GND	K15	IN	
GND	GND	K17	IN	
GND	GND	K19	IN	
GND	GND	K21	IN	
GND	GND	K23	IN	
GND	GND	K25	IN	
GND	GND	L02	IN	
GND	GND	M01	IN	
GND	GND	M03	IN	
GND	GND	M05	IN	
GND	GND	M07	IN	
GND	GND	M09	IN	
GND	GND	M11	IN	
GND	GND	M13	IN	
GND	GND	M15	IN	
GND	GND	M17	IN	
GND	GND	M19	IN	
GND	GND	M21	IN	
GND	GND	M23	IN	
GND	GND	M25	IN	
GND	GND	N04	IN	
GND	GND	N20	IN	
GND	GND	N24	IN	
GND	GND	P01	IN	
GND	GND	P03	IN	
GND	GND	P05	IN	
GND	GND	P07	IN	



Table 3-1. Pin/Signal Information Sorted by Pin Name (Sheet 10 of 15)

Pin Name	System Bus Signal Name	Pin Location	Input/Output	Notes
GND	GND	P09	IN	
GND	GND	P11	IN	
GND	GND	P13	IN	
GND	GND	P15	IN	
GND	GND	P17	IN	
GND	GND	P19	IN	
GND	GND	P21	IN	
GND	GND	P23	IN	
GND	GND	P25	IN	
GND	GND	R02	IN	
GND	GND	T01	IN	
GND	GND	T03	IN	
GND	GND	T05	IN	
GND	GND	T07	IN	
GND	GND	T09	IN	
GND	GND	T11	IN	
GND	GND	T13	IN	
GND	GND	T15	IN	
GND	GND	T17	IN	
GND	GND	T19	IN	
GND	GND	T21	IN	
GND	GND	T23	IN	
GND	GND	T25	IN	
GND	GND	U04	IN	
GND	GND	U20	IN	
GND	GND	U24	IN	
GND	GND	V01	IN	
GND	GND	V03	IN	
GND	GND	V05	IN	
GND	GND	V07	IN	
GND	GND	V09	IN	
GND	GND	V11	IN	
GND	GND	V13	IN	
GND	GND	V15	IN	
GND	GND	V17	IN	
GND	GND	V19	IN	
GND	GND	V21	IN	
GND	GND	V23	IN	
GND	GND	V25	IN	
GND	GND	W02	IN	
GND	GND	Y01	IN	
GND	GND	Y03	IN	
GND	GND	Y05	IN	
GND	GND	Y07	IN	

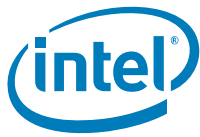

Table 3-1. Pin/Signal Information Sorted by Pin Name (Sheet 11 of 15)

Pin Name	System Bus Signal Name	Pin Location	Input/Output	Notes
GND	GND	Y09	IN	
GND	GND	Y11	IN	
GND	GND	Y13	IN	
GND	GND	Y15	IN	
GND	GND	Y17	IN	
GND	GND	Y19	IN	
GND	GND	Y21	IN	
GND	GND	Y23	IN	
GND	GND	Y25	IN	
GSEQ#	GSEQ#	AD14	IN	
HIT#	HIT#	AB10	IN/OUT	
HITM#	HITM#	AB12	IN/OUT	
IDO#	IDA0#/IPO#	AD02	IN	
ID1#	IDA1#/IP1#	AB02	IN	
ID2#	IDA2#/DHIT#	AC03	IN	
ID3#	IDA3#/IDB3#	AA03	IN	
ID4#	IDA4#/IDB4#	AD04	IN	
ID5#	IDA5#/IDB5#	AB04	IN	
ID6#	IDA6#/IDB6#	AE05	IN	
ID7#	IDA7#/IDB7#	AC05	IN	
ID8#	IDA8#/IDB8#	AD06	IN	
ID9#	IDA9#/IDB9#	AB06	IN	
IDS#	IDS#	AC07	IN	
IGNNE#	IGNNE#	AG23	N/C	
INIT#	INIT#	AF08	IN	
LINT0	INT	AF22	IN	
LINT1	NMI	AF24	IN	
LOCK#	LOCK#	AE15	N/C	
N/C		A04		
N/C		AB16		
N/C		AC17		
N/C		AC21		
N/C		AD18		
N/C		AE17		
N/C		AG05		
N/C		AG11		
N/C		AG17		
N/C		AG19		
N/C		AG21		
N/C		AH05		
N/C		AH11		
N/C		AH17		
N/C		AH19		
N/C		AH21		



Table 3-1. Pin/Signal Information Sorted by Pin Name (Sheet 12 of 15)

Pin Name	System Bus Signal Name	Pin Location	Input/Output	Notes
N/C		B04		
N/C		B06		
N/C		B08		
N/C		B14		
N/C		B16		
N/C		B20		
N/C		C03		
N/C		C13		
N/C		C15		
N/C		C25		
N/C		K02		
N/C		K12		
N/C		K14		
N/C		K24		
N/C		U05		
N/C		U11		
OUTEN	OUTEN	AF04	IN	Power pod signal
PMI#	PMI#	AE25	IN	
PPODGD#	PPODGD#	AF20	OUT	Power pod signal
PWRGOOD	PWRGOOD	AH15	IN	
REQ0#	REQA0#/LEN0#	AE09	IN/OUT	
REQ1#	WSNP#, D/C#/LEN1#	AF10	IN/OUT	
REQ2#	REQA2#/ REQB2#	AD10	IN/OUT	
REQ3#	ASZ0#/DSZ0#	AE11	IN/OUT	
REQ4#	ASZ1#/DSZ1#	AF12	IN/OUT	
REQ5#	REQ5#	AD12	IN/OUT	
RESET#	RESET#	AD20	IN	
RP#	RP#	AC13	IN/OUT	
RS0#	RS0#	AE07	IN	
RS1#	RS1#	AD08	IN	
RS2#	RS2#	AB08	IN	
RSP#	RSP#	AF06	IN	
SBSY#	SBSY#	AE13	IN/OUT	
SBSY0#	SBSY_C1#	AA13	OUT	
SBSY1#	SBSY_C2#	AC19	OUT	
SMA0	SMA0	B18	IN	SMBus signal
SMA1	SMA1	A17	IN	SMBus signal
SMA2	SMA2	A15	IN	SMBus signal
SMSC	SMSC	B24	IN	SMBus signal
SMSD	SMSD	B22	IN/OUT	SMBus signal
SMWP	SMWP	A21	IN	SMBus signal
STBN0#	STBN0#	F04	IN/OUT	
STBN1#	STBN1#	N05	IN/OUT	
STBN2#	STBN2#	F10	IN/OUT	

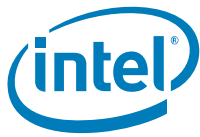

Table 3-1. Pin/Signal Information Sorted by Pin Name (Sheet 13 of 15)

Pin Name	System Bus Signal Name	Pin Location	Input/Output	Notes
STBN3#	STBN3#	N11	IN/OUT	
STBN4#	STBN4#	F16	IN/OUT	
STBN5#	STBN5#	N17	IN/OUT	
STBN6#	STBN6#	F22	IN/OUT	
STBN7#	STBN7#	N23	IN/OUT	
STBP0#	STBP0#	E05	IN/OUT	
STBP1#	STBP1#	M04	IN/OUT	
STBP2#	STBP2#	E11	IN/OUT	
STBP3#	STBP3#	M10	IN/OUT	
STBP4#	STBP4#	E17	IN/OUT	
STBP5#	STBP5#	M16	IN/OUT	
STBP6#	STBP6#	E23	IN/OUT	
STBP7#	STBP7#	M22	IN/OUT	
TCK	TCK	AG09	IN	JTAG
TDI	TDI	AG07	IN	JTAG
TDO	TDO	AH07	OUT	JTAG
TERMA	FSBT1	AF02	IN	
TERMB	FSBT2	AE03	IN	
THRMTRIP#	THRMTRIP#	AG25	OUT	
THRMALERT#	THRMALERT#	A07	OUT	
TMS	TMS	AH09	IN	JTAG
TND#	TND#	AC15	IN/OUT	
TRDY#	TRDY#	AF14	IN	
TRST#	TRST#	AE21	IN	JTAG
TUNER[1]	TUNER[1]	AH03	IN	
TUNER[2]	TUNER[2]	AG03	IN	
TUNER[3]	TUNER[3]	B08	IN	
VCCMON	VCCMON	A11	N/C	
VCTERM	VCTERM	A02	IN	
VCTERM	VCTERM	A06	IN	
VCTERM	VCTERM	A10	IN	
VCTERM	VCTERM	A14	IN	
VCTERM	VCTERM	A18	IN	
VCTERM	VCTERM	A22	IN	
VCTERM	VCTERM	A25	IN	
VCTERM	VCTERM	C01	IN	
VCTERM	VCTERM	C04	IN	
VCTERM	VCTERM	C08	IN	
VCTERM	VCTERM	C12	IN	
VCTERM	VCTERM	C16	IN	
VCTERM	VCTERM	C20	IN	
VCTERM	VCTERM	C24	IN	
VCTERM	VCTERM	E02	IN	
VCTERM	VCTERM	E06	IN	

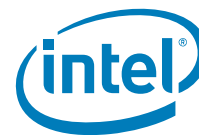

Table 3-1. Pin/Signal Information Sorted by Pin Name (Sheet 14 of 15)

Pin Name	System Bus Signal Name	Pin Location	Input/Output	Notes
VCTERM	VCTERM	E10	IN	
VCTERM	VCTERM	E14	IN	
VCTERM	VCTERM	E18	IN	
VCTERM	VCTERM	E22	IN	
VCTERM	VCTERM	G01	IN	
VCTERM	VCTERM	G04	IN	
VCTERM	VCTERM	G08	IN	
VCTERM	VCTERM	G12	IN	
VCTERM	VCTERM	G16	IN	
VCTERM	VCTERM	G20	IN	
VCTERM	VCTERM	G24	IN	
VCTERM	VCTERM	J02	IN	
VCTERM	VCTERM	J06	IN	
VCTERM	VCTERM	J10	IN	
VCTERM	VCTERM	J14	IN	
VCTERM	VCTERM	J18	IN	
VCTERM	VCTERM	J22	IN	
VCTERM	VCTERM	L01	IN	
VCTERM	VCTERM	L04	IN	
VCTERM	VCTERM	L08	IN	
VCTERM	VCTERM	L12	IN	
VCTERM	VCTERM	L16	IN	
VCTERM	VCTERM	L20	IN	
VCTERM	VCTERM	L24	IN	
VCTERM	VCTERM	N02	IN	
VCTERM	VCTERM	N06	IN	
VCTERM	VCTERM	N10	IN	
VCTERM	VCTERM	N14	IN	
VCTERM	VCTERM	N18	IN	
VCTERM	VCTERM	N22	IN	
VCTERM	VCTERM	R01	IN	
VCTERM	VCTERM	R04	IN	
VCTERM	VCTERM	R08	IN	
VCTERM	VCTERM	R12	IN	
VCTERM	VCTERM	R16	IN	
VCTERM	VCTERM	R20	IN	
VCTERM	VCTERM	R24	IN	
VCTERM	VCTERM	U02	IN	
VCTERM	VCTERM	U06	IN	
VCTERM	VCTERM	U10	IN	
VCTERM	VCTERM	U14	IN	
VCTERM	VCTERM	U18	IN	
VCTERM	VCTERM	U22	IN	



Table 3-1. Pin/Signal Information Sorted by Pin Name (Sheet 15 of 15)

Pin Name	System Bus Signal Name	Pin Location	Input/Output	Notes
VCTERM	VCTERM	U25	IN	
VSSMON	VSSMON	A09	N/C	

Table 3-2. Pin/Signal Information Sorted by Pin Location (Sheet 1 of 15)

Pin Name	System Bus Signal Name	Pin Location	Input/Output	Notes
GND	GND	A01	IN	
VCTERM	VCTERM	A02	IN	
GND	GND	A03	IN	
N/C		A04		
GND	GND	A05	IN	
VCTERM	VCTERM	A06	IN	
THRMLERT#	THRMLERT#	A07	OUT	
GND	GND	A08	IN	
VSSMON	VSSMON	A09	N/C	
VCTERM	VCTERM	A10	IN	
VCCMON	VCCMON	A11	N/C	
GND	GND	A13	IN	
VCTERM	VCTERM	A14	IN	
SMA2	SMA2	A15	IN	SMBus signal
GND	GND	A16	IN	
SMA1	SMA1	A17	IN	SMBus signal
VCTERM	VCTERM	A18	IN	
GND	GND	A19	IN	
GND	GND	A20	IN	
SMWP	SMWP	A21	IN	SMBus signal
VCTERM	VCTERM	A22	IN	
GND	GND	A23	IN	
GND	GND	A24	IN	
VCTERM	VCTERM	A25	IN	
3.3V		B02	IN	SMBus supply voltage
GND	GND	B03	IN	
N/C		B04		
GND	GND	B05	IN	
N/C		B06		
GND	GND	B07	IN	
Tuner[3]	Tuner[3]	B08	IN	
GND	GND	B09	IN	
GND	GND	B10	IN	
GND	GND	B11	IN	
GND	GND	B13	IN	
N/C		B14		
GND	GND	B15	IN	
N/C		B16		

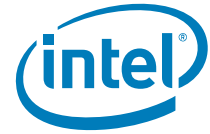

Table 3-2. Pin/Signal Information Sorted by Pin Location (Sheet 2 of 15)

Pin Name	System Bus Signal Name	Pin Location	Input/Output	Notes
GND	GND	B17	IN	
SMA0	SMA0	B18	IN	SMBus signal
GND	GND	B19	IN	
N/C		B20		
GND	GND	B21	IN	
SMSD	SMSD	B22	IN/OUT	SMBus signal
GND	GND	B23	IN	
SMSC	SMSC	B24	IN	SMBus signal
GND	GND	B25	IN	
VCTERM	VCTERM	C01	IN	
GND	GND	C02	IN	
N/C		C03		
VCTERM	VCTERM	C04	IN	
D002#	D02#	C05	IN/OUT	
GND	GND	C06	IN	
D000#	D00#	C07	IN/OUT	
VCTERM	VCTERM	C08	IN	
D035#	D35#	C09	IN/OUT	
GND	GND	C10	IN	
D033#	D33#	C11	IN/OUT	
VCTERM	VCTERM	C12	IN	
N/C		C13		
GND	GND	C14	IN	
N/C		C15		
VCTERM	VCTERM	C16	IN	
D073#	D73#	C17	IN/OUT	
GND	GND	C18	IN	
D070#	D70#	C19	IN/OUT	
VCTERM	VCTERM	C20	IN	
D099#	D99#	C21	IN/OUT	
GND	GND	C22	IN	
D097#	D97#	C23	IN/OUT	
VCTERM	VCTERM	C24	IN	
N/C		C25		
GND	GND	D01	IN	
D004#	D04#	D02	IN/OUT	
GND	GND	D03	IN	
D003#	D03#	D04	IN/OUT	
GND	GND	D05	IN	
D005#	D05#	D06	IN/OUT	
GND	GND	D07	IN	
D037#	D37#	D08	IN/OUT	
GND	GND	D09	IN	
D034#	D34#	D10	IN/OUT	

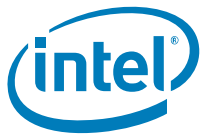

Table 3-2. Pin/Signal Information Sorted by Pin Location (Sheet 3 of 15)

Pin Name	System Bus Signal Name	Pin Location	Input/Output	Notes
GND	GND	D11	IN	
D036#	D36#	D12	IN/OUT	
GND	GND	D13	IN	
D065#	D65#	D14	IN/OUT	
GND	GND	D15	IN	
D066#	D66#	D16	IN/OUT	
GND	GND	D17	IN	
D064#	D64#	D18	IN/OUT	
GND	GND	D19	IN	
D102#	D102#	D20	IN/OUT	
GND	GND	D21	IN	
D098#	D98#	D22	IN/OUT	
GND	GND	D23	IN	
D104#	D104#	D24	IN/OUT	
GND	GND	D25	IN	
VCTERM	VCTERM	E02	IN	
D001#	D01#	E03	IN/OUT	
GND	GND	E04	IN	
STBP0#	STBP0#	E05	IN/OUT	
VCTERM	VCTERM	E06	IN	
D010#	D10#	E07	IN/OUT	
GND	GND	E08	IN	
D040#	D40#	E09	IN/OUT	
VCTERM	VCTERM	E10	IN	
STBP2#	STBP2#	E11	IN/OUT	
GND	GND	E12	IN	
D039#	D39#	E13	IN/OUT	
VCTERM	VCTERM	E14	IN	
D067#	D67#	E15	IN/OUT	
GND	GND	E16	IN	
STBP4#	STBP4#	E17	IN/OUT	
VCTERM	VCTERM	E18	IN	
D074#	D74#	E19	IN/OUT	
GND	GND	E20	IN	
D096#	D96#	E21	IN/OUT	
VCTERM	VCTERM	E22	IN	
STBP6#	STBP6#	E23	IN/OUT	
GND	GND	E24	IN	
D100#	D100#	E25	IN/OUT	
GND	GND	F01	IN	
D007#	D07#	F02	IN/OUT	
GND	GND	F03	IN	
STBNO#	STBNO#	F04	IN/OUT	
GND	GND	F05	IN	

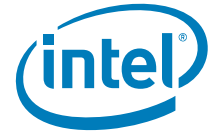

Table 3-2. Pin/Signal Information Sorted by Pin Location (Sheet 4 of 15)

Pin Name	System Bus Signal Name	Pin Location	Input/Output	Notes
D006#	D06#	F06	IN/OUT	
GND	GND	F07	IN	
D045#	D45#	F08	IN/OUT	
GND	GND	F09	IN	
STBN2#	STBN2#	F10	IN/OUT	
GND	GND	F11	IN	
D044#	D44#	F12	IN/OUT	
GND	GND	F13	IN	
D068#	D68#	F14	IN/OUT	
GND	GND	F15	IN	
STBN4#	STBN4#	F16	IN/OUT	
GND	GND	F17	IN	
D069#	D69#	F18	IN/OUT	
GND	GND	F19	IN	
D106#	D106#	F20	IN/OUT	
GND	GND	F21	IN	
STBN6#	STBN6#	F22	IN/OUT	
GND	GND	F23	IN	
D103#	D103#	F24	IN/OUT	
GND	GND	F25	IN	
VCTERM	VCTERM	G01	IN	
GND	GND	G02	IN	
D014#	D14#	G03	IN/OUT	
VCTERM	VCTERM	G04	IN	
D008#	D08#	G05	IN/OUT	
D015#	D15#	G07	IN/OUT	
VCTERM	VCTERM	G08	IN	
D038#	D38#	G09	IN/OUT	
D041#	D41#	G11	IN/OUT	
VCTERM	VCTERM	G12	IN	
D043#	D43#	G13	IN/OUT	
D071#	D71#	G15	IN/OUT	
VCTERM	VCTERM	G16	IN	
D072#	D72#	G17	IN/OUT	
D079#	D79#	G19	IN/OUT	
VCTERM	VCTERM	G20	IN	
D101#	D101#	G21	IN/OUT	
D108#	D108#	G23	IN/OUT	
VCTERM	VCTERM	G24	IN	
D107#	D107#	G25	IN/OUT	
D011#	D11#	H02	IN/OUT	
GND	GND	H03	IN	
D012#	D12#	H04	IN/OUT	
GND	GND	H05	IN	



Table 3-2. Pin/Signal Information Sorted by Pin Location (Sheet 5 of 15)

Pin Name	System Bus Signal Name	Pin Location	Input/Output	Notes
D009#	D09#	H06	IN/OUT	
GND	GND	H07	IN	
D042#	D42#	H08	IN/OUT	
GND	GND	H09	IN	
D032#	D32#	H10	IN/OUT	
GND	GND	H11	IN	
D046#	D46#	H12	IN/OUT	
GND	GND	H13	IN	
D075#	D75#	H14	IN/OUT	
GND	GND	H15	IN	
D076#	D76#	H16	IN/OUT	
GND	GND	H17	IN	
D077#	D77#	H18	IN/OUT	
GND	GND	H19	IN	
D111#	D111#	H20	IN/OUT	
GND	GND	H21	IN	
D105#	D105#	H22	IN/OUT	
GND	GND	H23	IN	
D109#	D109#	H24	IN/OUT	
GND	GND	H25	IN	
GND	GND	J01	IN	
VCTERM	VCTERM	J02	IN	
D013#	D13#	J03	IN/OUT	
GND	GND	J04	IN	
DEP01#	DEP1#	J05	IN/OUT	
VCTERM	VCTERM	J06	IN	
DEP00#	DEP0#	J07	IN/OUT	
GND	GND	J08	IN	
DEP04#	DEP4#	J09	IN/OUT	
VCTERM	VCTERM	J10	IN	
DEP05#	DEP5#	J11	IN/OUT	
GND	GND	J12	IN	
D047#	D47#	J13	IN/OUT	
VCTERM	VCTERM	J14	IN	
D078#	D78#	J15	IN/OUT	
GND	GND	J16	IN	
DEP09#	DEP9#	J17	IN/OUT	
VCTERM	VCTERM	J18	IN	
DEP08#	DEP8#	J19	IN/OUT	
GND	GND	J20	IN	
DEP12#	DEP12#	J21	IN/OUT	
VCTERM	VCTERM	J22	IN	
DEP13#	DEP13#	J23	IN/OUT	
GND	GND	J24	IN	



Table 3-2. Pin/Signal Information Sorted by Pin Location (Sheet 6 of 15)

Pin Name	System Bus Signal Name	Pin Location	Input/Output	Notes
D110#	D110#	J25	IN/OUT	
N/C		K02		
GND	GND	K03	IN	
D016#	D16#	K04	IN/OUT	
GND	GND	K05	IN	
D018#	D18#	K06	IN/OUT	
GND	GND	K07	IN	
D049#	D49#	K08	IN/OUT	
GND	GND	K09	IN	
D050#	D50#	K10	IN/OUT	
GND	GND	K11	IN	
N/C		K12		
GND	GND	K13	IN	
N/C		K14		
GND	GND	K15	IN	
D083#	D83#	K16	IN/OUT	
GND	GND	K17	IN	
D080#	D80#	K18	IN/OUT	
GND	GND	K19	IN	
D117#	D117#	K20	IN/OUT	
GND	GND	K21	IN	
D114#	D114#	K22	IN/OUT	
GND	GND	K23	IN	
N/C		K24		
GND	GND	K25	IN	
VCTERM	VCTERM	L01	IN	
GND	GND	L02	IN	
D017#	D17#	L03	IN/OUT	
VCTERM	VCTERM	L04	IN	
D019#	D19#	L05	IN/OUT	
D021#	D21#	L07	IN/OUT	
VCTERM	VCTERM	L08	IN	
D053#	D53#	L09	IN/OUT	
D056#	D56#	L11	IN/OUT	
VCTERM	VCTERM	L12	IN	
D052#	D52#	L13	IN/OUT	
D081#	D81#	L15	IN/OUT	
VCTERM	VCTERM	L16	IN	
D088#	D88#	L17	IN/OUT	
D082#	D82#	L19	IN/OUT	
VCTERM	VCTERM	L20	IN	
D112#	D112#	L21	IN/OUT	
D116#	D116#	L23	IN/OUT	
VCTERM	VCTERM	L24	IN	



Table 3-2. Pin/Signal Information Sorted by Pin Location (Sheet 7 of 15)

Pin Name	System Bus Signal Name	Pin Location	Input/Output	Notes
D113#	D113#	L25	IN/OUT	
GND	GND	M01	IN	
D020#	D20#	M02	IN/OUT	
GND	GND	M03	IN	
STBP1#	STBP1#	M04	IN/OUT	
GND	GND	M05	IN	
D028#	D28#	M06	IN/OUT	
GND	GND	M07	IN	
D048#	D48#	M08	IN/OUT	
GND	GND	M09	IN	
STBP3#	STBP3#	M10	IN/OUT	
GND	GND	M11	IN	
D051#	D51#	M12	IN/OUT	
GND	GND	M13	IN	
D084#	D84#	M14	IN/OUT	
GND	GND	M15	IN	
STBP5#	STBP5#	M16	IN/OUT	
GND	GND	M17	IN	
D086#	D86#	M18	IN/OUT	
GND	GND	M19	IN	
D118#	D118#	M20	IN/OUT	
GND	GND	M21	IN	
STBP7#	STBP7#	M22	IN/OUT	
GND	GND	M23	IN	
D115#	D115#	M24	IN/OUT	
GND	GND	M25	IN	
VCTERM	VCTERM	N02	IN	
D023#	D23#	N03	IN/OUT	
GND	GND	N04	IN	
STBN1#	STBN1#	N05	IN/OUT	
VCTERM	VCTERM	N06	IN	
D022#	D22#	N07	IN/OUT	
D058#	D58#	N09	IN/OUT	
VCTERM	VCTERM	N10	IN	
STBN3#	STBN3#	N11	IN/OUT	
D055#	D55#	N13	IN/OUT	
VCTERM	VCTERM	N14	IN	
D091#	D91#	N15	IN/OUT	
STBN5#	STBN5#	N17	IN/OUT	
VCTERM	VCTERM	N18	IN	
D085#	D85#	N19	IN/OUT	
GND	GND	N20	IN	
D127#	D127#	N21	IN/OUT	
VCTERM	VCTERM	N22	IN	



Table 3-2. Pin/Signal Information Sorted by Pin Location (Sheet 8 of 15)

Pin Name	System Bus Signal Name	Pin Location	Input/Output	Notes
STBN7#	STBN7#	N23	IN/OUT	
GND	GND	N24	IN	
D119#	D119#	N25	IN/OUT	
GND	GND	P01	IN	
D027#	D27#	P02	IN/OUT	
GND	GND	P03	IN	
D024#	D24#	P04	IN/OUT	
GND	GND	P05	IN	
D026#	D26#	P06	IN/OUT	
GND	GND	P07	IN	
D054#	D54#	P08	IN/OUT	
GND	GND	P09	IN	
D061#	D61#	P10	IN/OUT	
GND	GND	P11	IN	
D057#	D57#	P12	IN/OUT	
GND	GND	P13	IN	
D087#	D87#	P14	IN/OUT	
GND	GND	P15	IN	
D093#	D93#	P16	IN/OUT	
GND	GND	P17	IN	
D095#	D95#	P18	IN/OUT	
GND	GND	P19	IN	
D122#	D122#	P20	IN/OUT	
GND	GND	P21	IN	
D125#	D125#	P22	IN/OUT	
GND	GND	P23	IN	
D120#	D120#	P24	IN/OUT	
GND	GND	P25	IN	
VCTERM	VCTERM	R01	IN	
GND	GND	R02	IN	
D025#	D25#	R03	IN/OUT	
VCTERM	VCTERM	R04	IN	
D029#	D29#	R05	IN/OUT	
D031#	D31#	R07	IN/OUT	
VCTERM	VCTERM	R08	IN	
D063#	D63#	R09	IN/OUT	
D060#	D60#	R11	IN/OUT	
VCTERM	VCTERM	R12	IN	
D059#	D59#	R13	IN/OUT	
D092#	D92#	R15	IN/OUT	
VCTERM	VCTERM	R16	IN	
D089#	D89#	R17	IN/OUT	
D090#	D90#	R19	IN/OUT	
VCTERM	VCTERM	R20	IN	

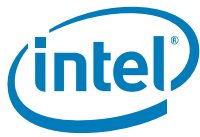

Table 3-2. Pin/Signal Information Sorted by Pin Location (Sheet 9 of 15)

Pin Name	System Bus Signal Name	Pin Location	Input/Output	Notes
D124#	D124#	R21	IN/OUT	
D126#	D126#	R23	IN/OUT	
VCTERM	VCTERM	R24	IN	
D121#	D121#	R25	IN/OUT	
GND	GND	T01	IN	
DO30#	D30#	T02	IN/OUT	
GND	GND	T03	IN	
DEPO3#	DEP3#	T04	IN/OUT	
GND	GND	T05	IN	
DEPO2#	DEP2#	T06	IN/OUT	
GND	GND	T07	IN	
DEPO6#	DEP6#	T08	IN/OUT	
GND	GND	T09	IN	
DEPO7#	DEP7#	T10	IN/OUT	
GND	GND	T11	IN	
DO62#	D62#	T12	IN/OUT	
GND	GND	T13	IN	
DO94#	D94#	T14	IN/OUT	
GND	GND	T15	IN	
DEP11#	DEP11#	T16	IN/OUT	
GND	GND	T17	IN	
DEP10#	DEP10#	T18	IN/OUT	
GND	GND	T19	IN	
DEP14#	DEP14#	T20	IN/OUT	
GND	GND	T21	IN	
DEP15#	DEP15#	T22	IN/OUT	
GND	GND	T23	IN	
D123#	D123#	T24	IN/OUT	
GND	GND	T25	IN	
VCTERM	VCTERM	U02	IN	
A005#	AA05#/EXF2#	U03	IN/OUT	
GND	GND	U04	IN	
N/C		U05		
VCTERM	VCTERM	U06	IN	
A009#	AA09#/BE1#	U07	IN/OUT	
A018#	AA18#/DID2#	U09	IN/OUT	
VCTERM	VCTERM	U10	IN	
N/C		U11		
A016#	AA16#/DID0#	U13	IN/OUT	
VCTERM	VCTERM	U14	IN	
A028#	AA28#/xTPRValue1#	U15	IN/OUT	
BNR#	BNR#	U17	IN/OUT	
VCTERM	VCTERM	U18	IN	
A027#	AA27#/xTPRValue0#	U19	IN/OUT	



Table 3-2. Pin/Signal Information Sorted by Pin Location (Sheet 10 of 15)

Pin Name	System Bus Signal Name	Pin Location	Input/Output	Notes
GND	GND	U20	IN	
A048#	AA48#/AB48#	U21	IN/OUT	
VCTERM	VCTERM	U22	IN	
A042#	AA42#/AB42#	U23	IN/OUT	
GND	GND	U24	IN	
VCTERM	VCTERM	U25	IN	
GND	GND	V01	IN	
A004#	AA04#/EXF1#	V02	IN/OUT	
GND	GND	V03	IN	
A010#	AA10#/BE2#	V04	IN/OUT	
GND	GND	V05	IN	
A003#	AA03#/EXF0#	V06	IN/OUT	
GND	GND	V07	IN	
A015#	AA15#/BE7#	V08	IN/OUT	
GND	GND	V09	IN	
A020#	AA20#/DID4#	V10	IN/OUT	
GND	GND	V11	IN	
A019#	AA19#/DID3#	V12	IN/OUT	
GND	GND	V13	IN	
A031#	AA31#/xTPRDisable#	V14	IN/OUT	
GND	GND	V15	IN	
A038#	AA38#/AB38#	V16	IN/OUT	
GND	GND	V17	IN	
A029#	AA29#/xTPRValue2#	V18	IN/OUT	
GND	GND	V19	IN	
A045#	AA45#/AB45#	V20	IN/OUT	
GND	GND	V21	IN	
A047#	AA47#/AB47#	V22	IN/OUT	
GND	GND	V23	IN	
A040#	AA40#/AB40#	V24	IN/OUT	
GND	GND	V25	IN	
GND	GND	W02	IN	
A006#	AA06#/EXF3#	W03	IN/OUT	
A012#	AA12#/BE4#	W05	IN/OUT	
A014#	AA14#/BE6#	W07	IN/OUT	
A021#	AA21#/DID5#	W09	IN/OUT	
A026#	AA26#/AB26#	W11	IN/OUT	
A022#	AA22#/DID6#	W13	IN/OUT	
A037#	AA37#/AB37#	W15	IN/OUT	
A032#	AA32#/ATTR0#	W17	IN/OUT	
A030#	AA30#/xTPRValue3#	W19	IN/OUT	
A044#	AA44#/AB44#	W21	IN/OUT	
A046#	AA46#/AB46#	W23	IN/OUT	
A041#	AA41#/AB41#	W25	IN/OUT	



Table 3-2. Pin/Signal Information Sorted by Pin Location (Sheet 11 of 15)

Pin Name	System Bus Signal Name	Pin Location	Input/Output	Notes
GND	GND	Y01	IN	
A007#	AA07#/EXF4#	Y02	IN/OUT	
GND	GND	Y03	IN	
A013#	AA13#/BE5#	Y04	IN/OUT	
GND	GND	Y05	IN	
A008#	AA08#/BE0#	Y06	IN/OUT	
GND	GND	Y07	IN	
A017#	AA17#/DID1#	Y08	IN/OUT	
GND	GND	Y09	IN	
A024#	AA24#/DID8#	Y10	IN/OUT	
GND	GND	Y11	IN	
A025#	AA25#/DID9#	Y12	IN/OUT	
GND	GND	Y13	IN	
A034#	AA34#/ATTR2#	Y14	IN/OUT	
GND	GND	Y15	IN	
A036#	AA36#/AB36#	Y16	IN/OUT	
GND	GND	Y17	IN	
A035#	AA35#/ATTR3#	Y18	IN/OUT	
GND	GND	Y19	IN	
A039#	AA39#/AB39#	Y20	IN/OUT	
GND	GND	Y21	IN	
A049#	AA49#/AB49#	Y22	IN/OUT	
GND	GND	Y23	IN	
A043#	AA43#/AB43#	Y24	IN/OUT	
GND	GND	Y25	IN	
GND	GND	AA02	IN	
ID3#	IDA3#/IDB3#	AA03	IN	
A011#	AA11#/BE3#	AA05	IN/OUT	
DRDY0#	DRDY_C1#	AA07	OUT	
DBSY0#	DBSY_C1#	AA09	OUT	
A023#	AA23#/DID7#	AA11	IN/OUT	
SBSY0#	SBSY_C1#	AA13	OUT	
BINIT#	BINIT#	AA15	IN/OUT	
A033#	AA33#/ATTR1#	AA17	IN/OUT	
DBSY1#	DBSY_C2#	AA19	OUT	
GND	GND	AA20	IN	
DRDY1#	DRDY_C2#	AA21	OUT	
AP1#	AP1#	AA23	IN/OUT	
GND	GND	AA24	IN	
AP0#	AP0#	AA25	IN/OUT	
GND	GND	AB01	IN	
ID1#	IDA1#/IP1#	AB02	IN	
GND	GND	AB03	IN	
ID5#	IDA5#/IDB5#	AB04	IN	

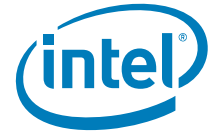

Table 3-2. Pin/Signal Information Sorted by Pin Location (Sheet 12 of 15)

Pin Name	System Bus Signal Name	Pin Location	Input/Output	Notes
GND	GND	AB05	IN	
ID9#	IDA9#/IDB9#	AB06	IN	
GND	GND	AB07	IN	
RS2#	RS2#	AB08	IN	
GND	GND	AB09	IN	
HIT#	HIT#	AB10	IN/OUT	
GND	GND	AB11	IN	
HITM#	HITM#	AB12	IN/OUT	
GND	GND	AB13	IN	
DEFER#	DEFER#	AB14	IN	
GND	GND	AB15	IN	
N/C		AB16		
GND	GND	AB17	IN	
BR2#	BREQ2#	AB18	IN	
GND	GND	AB19	IN	
ADS#	ADS#	AB20	IN/OUT	
GND	GND	AB21	IN	
BERR#	BERR#	AB22	IN/OUT	
GND	GND	AB23	IN	
BPM5#	BPM5#	AB24	IN/OUT	
GND	GND	AB25	IN	
GND	GND	AC02	IN	
ID2#	IDA2#/DHIT#	AC03	IN	
ID7#	IDA7#/IDB7#	AC05	IN	
IDS#	IDS#	AC07	IN	
DBSY#	DBSY#	AC09	IN/OUT	
DRDY#	DRDY#	AC11	IN/OUT	
RP#	RP#	AC13	IN/OUT	
TND#	TND#	AC15	IN/OUT	
N/C		AC17		
SBSY1#	SBSY_C2#	AC19	OUT	
N/C#		AC21		
BPM3#	BPM3#	AC23	IN/OUT	
GND	GND	AC24	IN	
BPM1#	BPM1#	AC25	IN/OUT	
GND	GND	AD01	IN	
ID0#	IDA0#/IP0#	AD02	IN	
GND	GND	AD03	IN	
ID4#	IDA4#/IDB4#	AD04	IN	
GND	GND	AD05	IN	
ID8#	IDA8#/IDB8#	AD06	IN	
GND	GND	AD07	IN	
RS1#	RS1#	AD08	IN	
GND	GND	AD09	IN	



Table 3-2. Pin/Signal Information Sorted by Pin Location (Sheet 13 of 15)

Pin Name	System Bus Signal Name	Pin Location	Input/Output	Notes
REQ2#	REQA2#/ REQB2#	AD10	IN/OUT	
GND	GND	AD11	IN	
REQ5#	REQ5#	AD12	IN/OUT	
GND	GND	AD13	IN	
GSEQ#	GSEQ#	AD14	IN	
GND	GND	AD15	IN	
BR1#	BREQ1#	AD16	IN	
GND	GND	AD17	IN	
N/C		AD18		
GND	GND	AD19	IN	
RESET#	RESET#	AD20	IN	
GND	GND	AD21	IN	
BPM0#	BPM0#	AD22	IN/OUT	
GND	GND	AD23	IN	
BPM4#	BPM4#	AD24	IN/OUT	
GND	GND	AD25	IN	
GND	GND	AE02	IN	
TERMB	FSBT2	AE03		
ID6#	IDA6#/IDB6#	AE05	IN	
RS0#	RS0#	AE07	IN	
REQ0#	REQA0#/LENO#	AE09	IN/OUT	
REQ3#	ASZ0#/DSZ0#	AE11	IN/OUT	
SBSY#	SBSY#	AE13	IN/OUT	
LOCK#	LOCK#	AE15	N/C	
N/C		AE17		
BPRI#	BPRI#	AE19	IN	
TRST#	TRST#	AE21	IN	
BPM2#	BPM2#	AE23	IN/OUT	
GND	GND	AE24	IN	
PMI#	PMI#	AE25	IN	
GND	GND	AF01	IN	
TERM	FSBT	AF02	IN	
OUTEN	OUTEN	AF04	IN	Power pod signal
GND	GND	AF05	IN	
RSP#	RSP#	AF06	IN	
GND	GND	AF07	IN	
INIT#	INIT#	AF08	IN	
GND	GND	AF09	IN	
REQ1#	WSNP#, D/C#/LEN1#	AF10	IN/OUT	
GND	GND	AF11	IN	
REQ4#	ASZ1#/DSZ1#	AF12	IN/OUT	
GND	GND	AF13	IN	
TRDY#	TRDY#	AF14	IN	
GND	GND	AF15	IN	



Table 3-2. Pin/Signal Information Sorted by Pin Location (Sheet 14 of 15)

Pin Name	System Bus Signal Name	Pin Location	Input/Output	Notes
BR0#	BREQ0#	AF16	IN/OUT	
GND	GND	AF17	IN	
BR3#	BREQ3#	AF18	IN	
GND	GND	AF19	IN	
PPODGD#	PPODGD#	AF20	OUT	Power pod signal
GND	GND	AF21	IN	
LINT0	INT	AF22	IN	
LINT1	NMI	AF24	IN	
GND	GND	AG02	IN	
TUNER[2]		AG03	IN	
GND	GND	AG04	IN	
N/C		AG05		
GND	GND	AG06	IN	
TDI	TDI	AG07	IN	JTAG
GND	GND	AG08	IN	
TCK	TCK	AG09	IN	JTAG
GND	GND	AG10	IN	
N/C		AG11		
GND	GND	AG12	IN	
BCLKp	CLK	AG13	IN	
GND	GND	AG14	IN	
CPUPRES#	CPUPRES#	AG15	OUT	Power pod signal
GND	GND	AG16	IN	
N/C		AG17		
GND	GND	AG18	IN	
N/C		AG19		
GND	GND	AG20	IN	
N/C		AG21		
GND	GND	AG22	IN	
IGNNE#	IGNNE#	AG23	N/C	
GND	GND	AG24	IN	
THRMTRIP#	THRMTRIP#	AG25	OUT	Thermal trip
GND	GND	AH01	IN	
TUNER[1]		AH03	IN	
N/C		AH05		
TDO	TDO	AH07	OUT	JTAG
TMS	TMS	AH09	IN	JTAG
N/C		AH11		
BCLKn	BCLKN	AH13	IN	
PWRGOOD	PWRGOOD	AH15	IN	
N/C		AH17		
N/C		AH19		
N/C		AH21		



Table 3-2. Pin/Signal Information Sorted by Pin Location (Sheet 15 of 15)

Pin Name	System Bus Signal Name	Pin Location	Input/Output	Notes
A20M#	A20M#	AH23	N/C	
FERR#	FERR#	AH25	OUT	

§

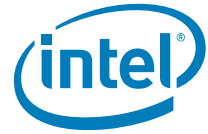

4 Mechanical Specifications

This chapter provides the mechanical specifications of the Dual-Core Intel Itanium processor 9000 and 9100 series.

4.1 Processor Package Dimensions

Figure 4-1 through Figure 4-5 provide package mechanical drawings and dimensions of the processor. Table 4-1 and Table 4-2 provide additional details on the package dimensions. The main components of processor package are identified in Figure 4-2. All specified package dimensions are in millimeters.

Figure 4-1 illustrates key package mechanical features. These features enable package integration with socket, power pod, and cooling solution.

- **Vcore, Vcache, Vfixed, GND, and VID Pads:** Contact pads for delivering power and I/O signals from the voltage regulator to the processor through its substrate.
- **Socket Alignment Keyways:** They define package position in X and Y direction with respect to socket for proper alignment of package pins to socket contact holes.
- **Pin Shroud Alignment Keyways:** They define pin shroud position in X and Y direction with respect to processor.
- **Pin 1 Indicators:** Identifies package orientation with respect to socket and motherboard.
- **Integrated Heat Spreader (IHS):** Enhances dissipation of heat generated by the processor. Provides interface surface between processor and cooling solution.
- **Substrate:** Processor mechanical and electrical integration vehicle with the motherboard and processor enabling components.
- **Pin Field (Grid):** 28 x 25 partially-filled pin field for transmitting signals to and from processor to motherboard.
- **Voltage Regulator Connector Back Plate Keyway:** It defines the VR connector back plate position in X and Y direction with respect to the processor.

Figure 4-1. Processor Package

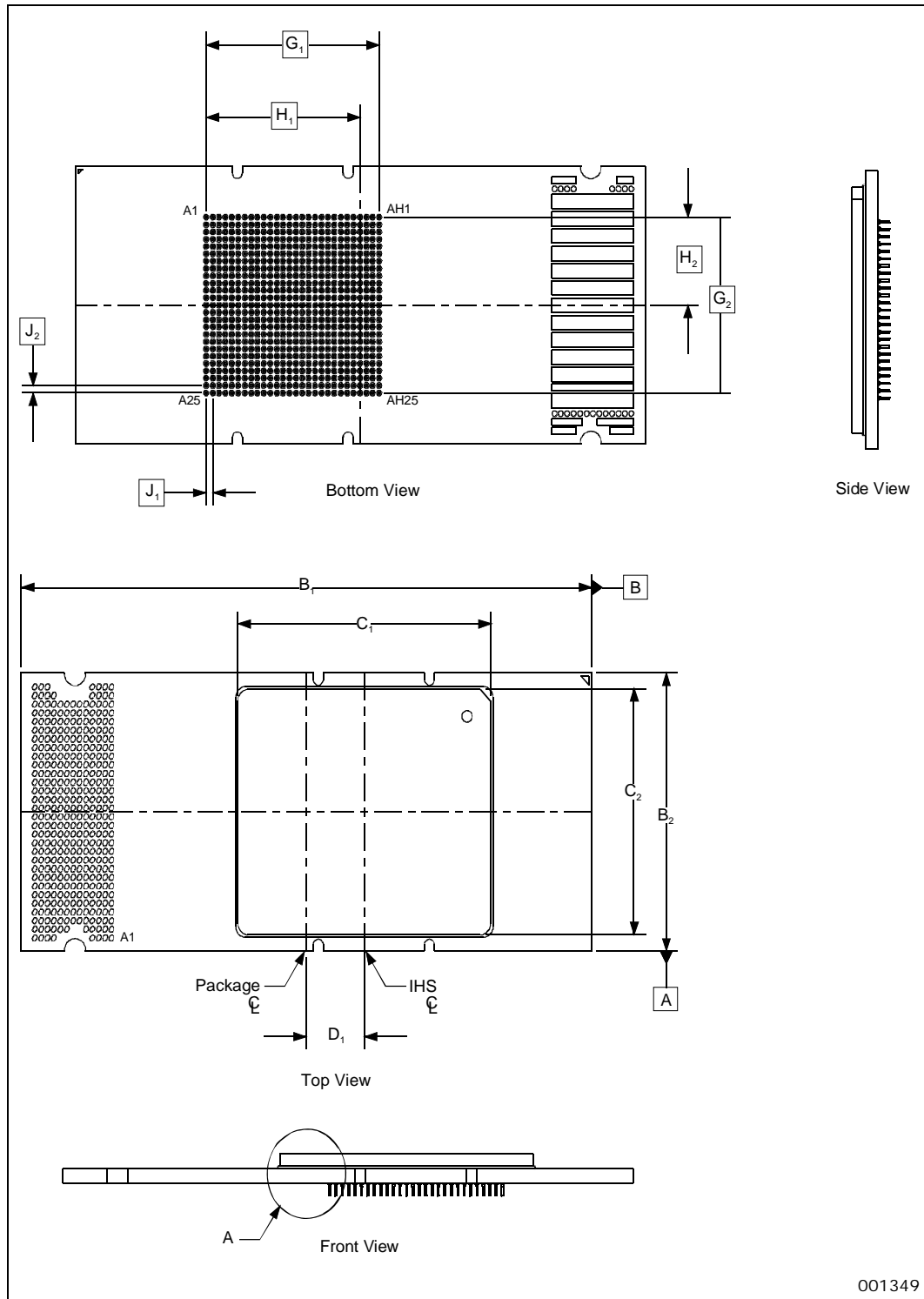

001349



Table 4-1. Processor Package Dimensions

SYMBOL	MILLIMETERS		COMMENTS
	MIN	MAX	
B ₁	112.9	113.1	
B ₂	48.16	48.36	
C ₁	49.9	50.1	
C ₂	42.4	42.6	
D ₁	11.5		
F ₂	4.668	5.368	
G ₁	34.29 BASIC		
G ₂	30.48 BASIC		
H ₁	30.5 BASIC		
H ₂	15.24 BASIC		
J ₁	1.27 BASIC		
J ₂	1.27 BASIC		
P	0.28	0.33	

Figure 4-2. Package Height and Pin Dimensions



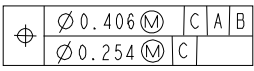
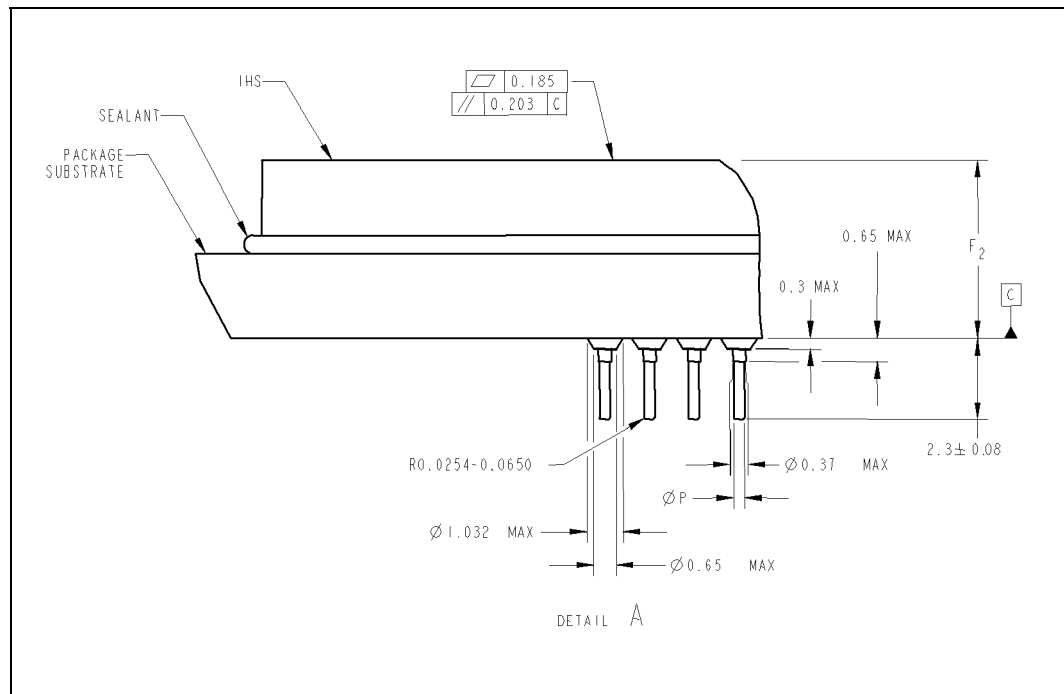
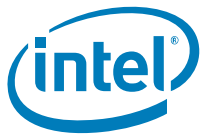

Table 4-2. Processor Package Mechanical Interface Dimensions

SYMBOL	MILLIMETERS		COMMENTS
	MIN	MAX	
G ₃	15.24 BASIC		<div style="border: 1px solid black; padding: 2px; display: inline-block;"> \varnothing 0.15 C D </div>
G ₄	43.5 BASIC		
H ₃	7.263 BASIC		
H ₄	21.76 BASIC		
J ₃	1.27 BASIC		
J ₄	1.5 BASIC		
M ₂	0.875	0.925	
M ₃	1.275	1.325	
M ₄	25° BASIC		<div style="border: 1px solid black; padding: 2px; display: inline-block;"> \varnothing 0.15 C D </div>

SYMBOL	MILLIMETERS		COMMENTS
	MIN	MAX	
R ₁	4.2	4.3	<div style="border: 1px solid black; padding: 2px; display: inline-block;"> \varnothing \varnothing 0.15 C A B </div>
R ₂	1.87	2.13	<div style="border: 1px solid black; padding: 2px; display: inline-block;"> \varnothing \varnothing 1 M C A B \varnothing 0.25 M C A </div>
T ₁	45.745 BASIC		
T ₂	24 BASIC		
V ₁	2.405 BASIC		
V ₂	22 BASIC		
W ₁	24.405 BASIC		
W ₂	22 BASIC		

Figure 4-3. Processor Package Mechanical Interface Dimensions

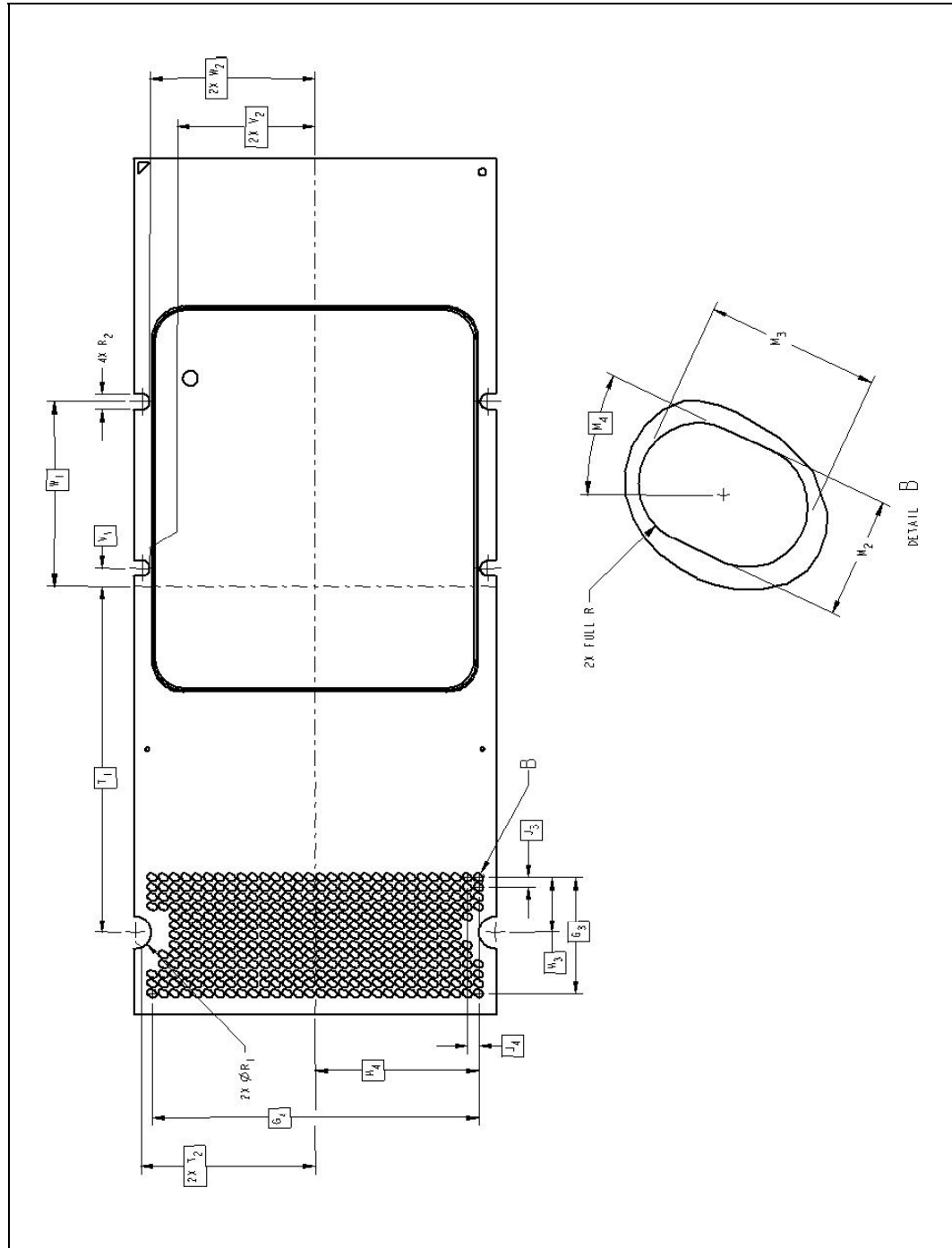
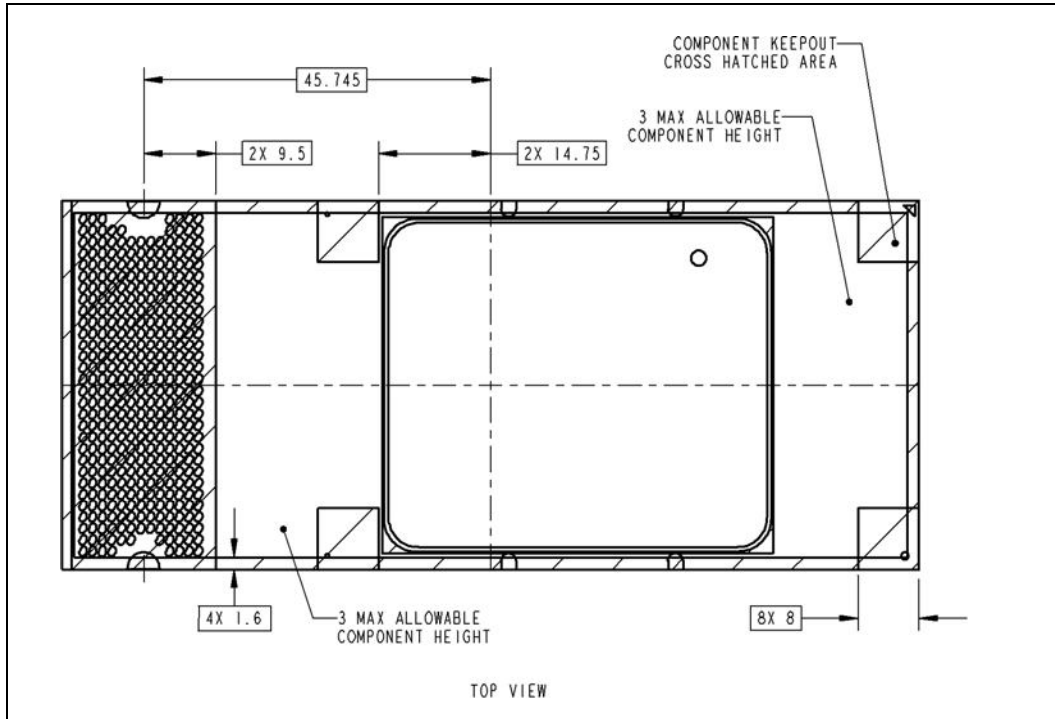
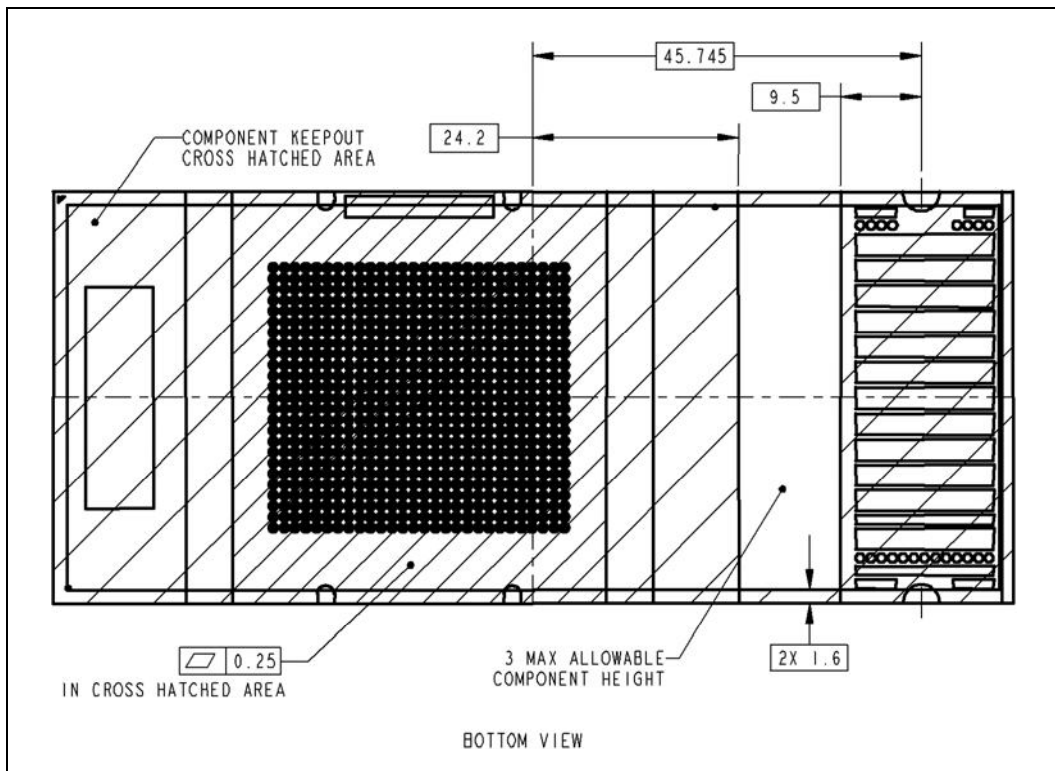

Figure 4-4. Processor Package Top-Side Components Height Dimensions



Note: Keepout zones indicate no components will be on the processor package.

Figure 4-5. Processor Package Bottom-Side Components Height Dimensions



Note: Keepout zones indicate no components will be on the processor package.



4.1.1 Voltage Regulator (MVR) to Processor Package Interface

Critical package mechanical requirements at its interface with the MVR are identified in Figure 4-6 and Table 4-3. The processor interface boundary conditions with which MVR must comply during and after installation are outlined in Table 4-3. These requirements are intended to minimize potential damage to the processor that may result from installation of the MVR.

Figure 4-6. Processor to MVR Interface Loads

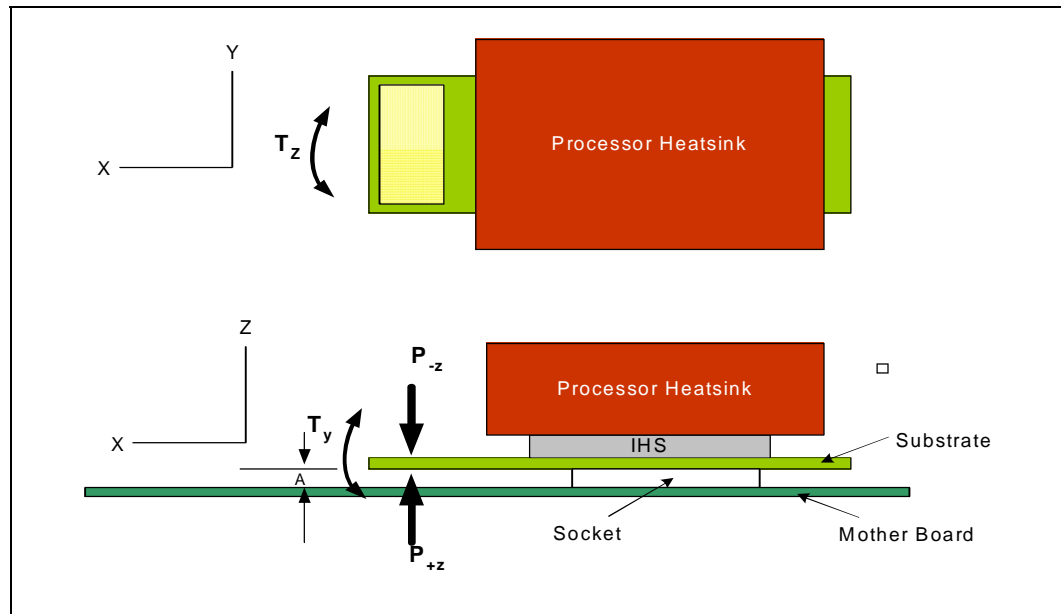

Table 4-3. Processor Package Load Limits at Power Tab (Sheet 1 of 2)

Parameter	Description	Value ¹	Comments
A	Final position of the package at the power tab (unloaded) with respect to system board	3.8 +/- 0.1mm	Position of the processor power tab is based on the height of the mPGA700 ZIF socket height from the mother post SMT
P	Allowable load on the package in +z and -z direction	22.25N max	
d	Allowable displacement at the processor power tab in z direction under load P	+/- 0.3 mm max	
Tz	Allowable torque on the package tip in z axis	0	Package loading in Y direction is not allowed. Hence, zero torque in Z-axis

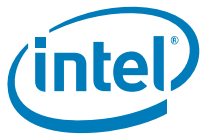

Table 4-3. Processor Package Load Limits at Power Tab (Sheet 2 of 2)

Parameter	Description	Value ¹	Comments
Tx	Allowable torque at the package power tab in X axis	0.57Nm max	
T+y	Allowable torque at the package power tab in +y direction	1.24 Nm max	Torque on the package edge in +Y direction is determined by the load applied in -Z and the distance from the edge the package to the socket.
T-y	Allowable torque at the package power tab in -y direction	0.93Nm max	Torque on the package edge in -Y direction is determined by the load applied in +Z and the distance from the edge the package to the heatsink base. To determine T+y, distance from the edge the package to the socket of 55.7mm is applied To determine T-y, distance from the edge the package to the heatsink pedestal of 42mm is applied

Notes:

1. Load determination done with 100-lb. load on the processor heatsink.

4.2 Package Marking

The following section details the processor top-side and bottom-side markings for engineering samples and production units. This is provided to aid in identification. Specific details regarding individual fields in the product markings will be furnished in a future release of this document.

4.2.1 Processor Top-Side Marking

The top-side mark is a laser marking on the IHS. [Figure 4-7](#) shows the general location of the processor top-side mark that provides the following information:

- Intel[®]
- Itanium[®] Processor Family Legal Mark
- Assembly Process Order (APO) Number
- Unit Serial Number
- 2D Matrix Mark

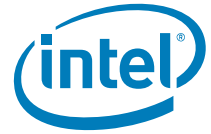
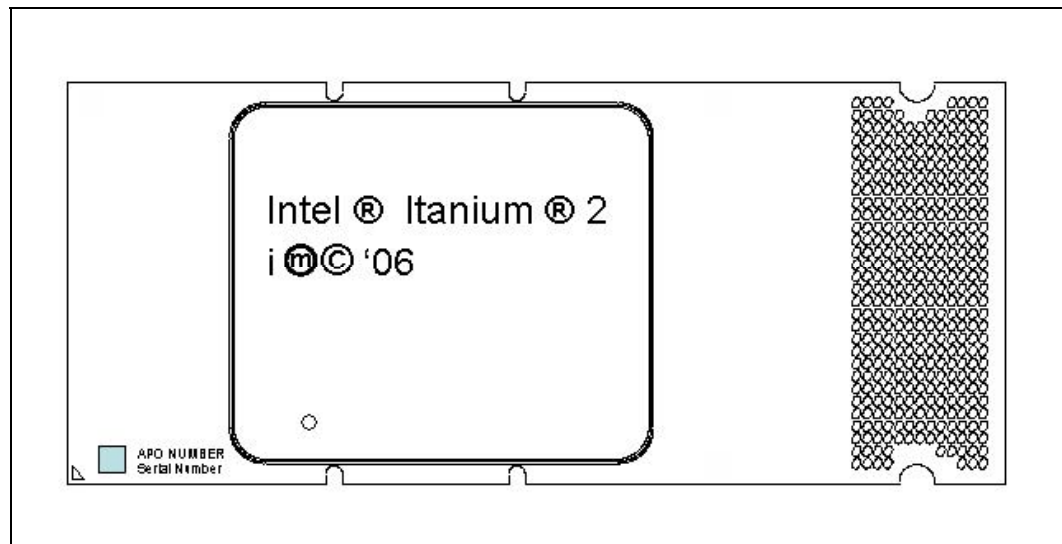
**Figure 4-7. Processor Top-Side Marking on IHS**

4.2.2 Processor Bottom-Side Marking

The processor bottom-side mark for the product is a laser marking on the pin side of the interposer. [Figure 4-8](#) shows the placement of the laser marking on the pin side of interposer. The processor bottom-side mark provides the following information:

- Product ID
- S-Spec
- Finish Process Order (FPO)
- 2D Matrix Mark

Figure 4-8. Processor Bottom-Side Marking Placement on Interposer

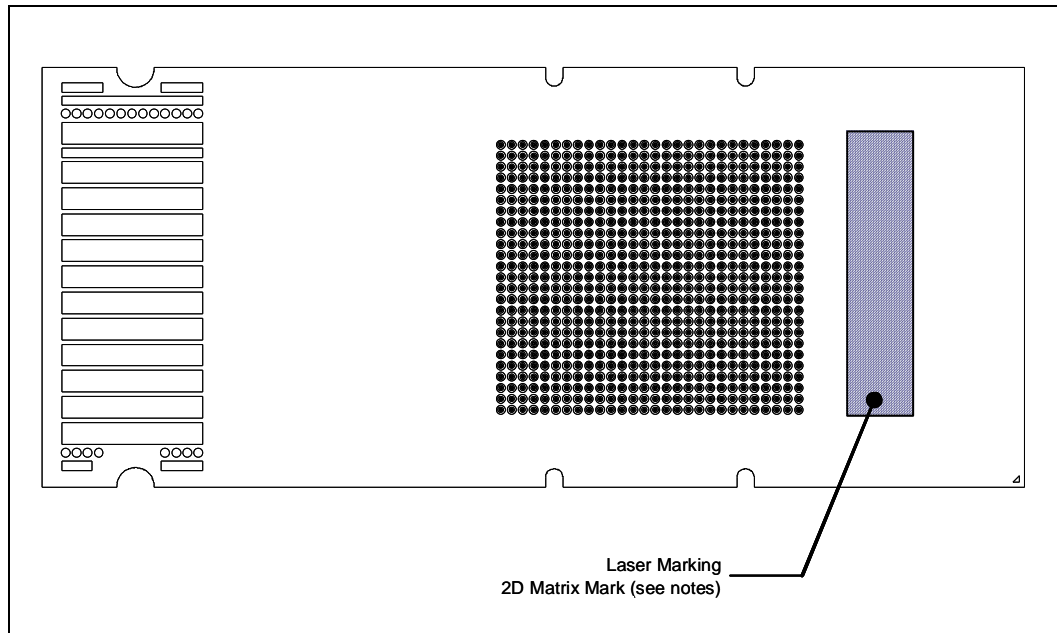

§



5 Thermal Specifications

This chapter provides a description of the thermal features relating to the Dual-Core Intel Itanium processor 9000 and 9100 series.

5.1 Thermal Features

The processor has an internal thermal circuit which senses when a certain temperature is reached on the processor core. This circuit is used for controlling various thermal states. In addition, an on-chip thermal diode is available for use by the thermal sensing device on the processor. [Figure 5-1](#) shows the relationship between temperature, time, and the thermal alert, enhanced thermal management (ETM), and thermal trip points.

Note: [Figure 5-1](#) is not intended to show a linear relationship in time or temperature as a processor's thermal state advances from one state to the next state when the cooling solution fails to control the processor temperature, as this is affected by many factors such as cooling solution performance degradation and processor workload variations.

Figure 5-1. Dual-Core Intel® Itanium® Processor 9000 and 9100 Series Thermal Features

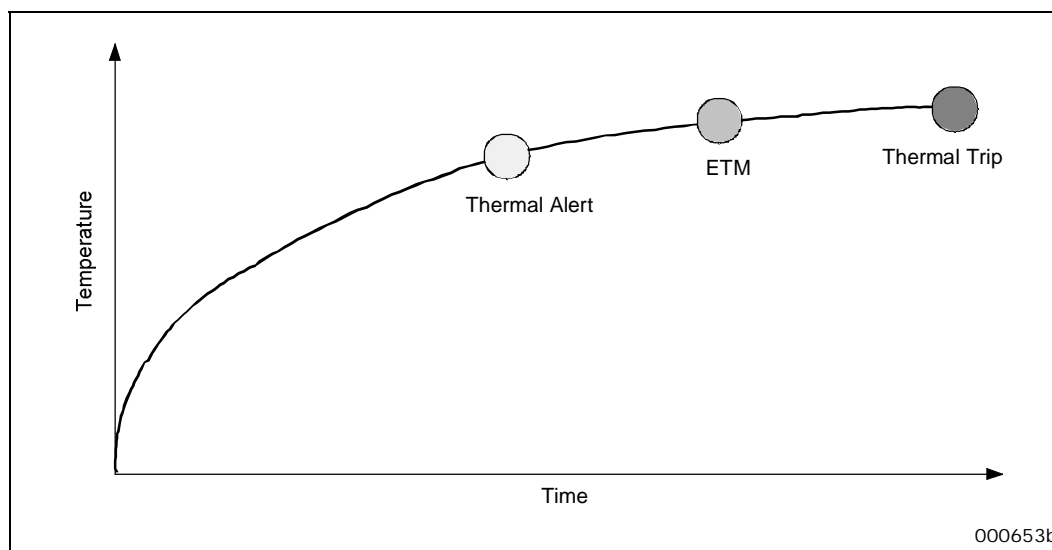

5.1.1 Thermal Alert

THRMALERT# is a programmable thermal alert signal which is part of the processor system management feature. THRMALERT# is asserted when the measured temperature from the processor thermal diode equals or exceeds the temperature threshold data programmed in the high temp (THIGH) or low temp (TLOW) registers on the sensor. Intel recommends using the upper temperature reference byte listed in the Processor Information ROM when programming the THIGH register (see [Chapter 6](#) for more details). This signal can be used by the platform to implement thermal regulation features such as generating an external interrupt to tell the operating system that the processor core die temperature is increasing.

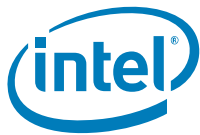

5.1.2 Enhanced Thermal Management

ETM is a power and thermal protection feature. On the Dual-Core Intel Itanium processor 9000 and 9100 series, ETM uses power and thermal sensing devices on the die to monitor entry points, indicating dangerous operation exceeding the thermal or power specification. Once the sensing devices observe the temperature rising above the power or thermal entry point, the processor will enter a low power mode of execution and notify the system by sending a Correctable Machine Check Interrupt (CMCI). The processor will remain in this low power mode until the power and temperature decrease below the entry points and remain there for approximately one second, at which point it will send another CMCI and resume normal operation. If the power and temperature cannot be reduced, and continue to rise to critical levels, the processor will assert Power Trip or Thermal Trip. The ETM feature may be disabled through the PAL.

5.1.3 Power Trip

The Dual-Core Intel Itanium processor 9000 and 9100 series protects itself and the MVR from catastrophic over power by use of an internal power sensor. The sensor trip point is set above the normal operating power to ensure that there are no false trips. The processor will signal a continuable MCA when the power draw exceeds a safe operating level.

Warning: Data will be lost if the MVR overheats and shuts down as a result of an extended over power condition.

Once power trip is activated, the processor can continue operation, but may continue to signal continuable MCAs as long as the over power condition exists.

5.1.4 Thermal Trip

The Dual-Core Intel Itanium processor 9000 and 9100 series protects itself from catastrophic overheating by use of an internal thermal sensor. The sensor trip point is set well above the normal operating temperature to ensure that there are no false trips. The processor will stop all execution when the junction temperature exceeds a safe operating level.

Warning: Data will be lost if the processor goes into thermal trip (signaled to the system by the THRMTRIP# pin).

Once thermal trip is activated, the processor remains stopped until RESET# is asserted. The processor case temperature must drop below the specified maximum before issuing a reset to the processor. Please see [Section 5.2](#) for details on case temperature.

5.2 Case Temperature

See [Table 5-1](#) for the case temperature specifications for the Dual-Core Intel Itanium processor 9000 and 9100 series. The case temperature is defined as the temperature measured at the center of the top surface of the IHS.

Warning: Data may be lost if the case temperature exceeds the specified maximum.

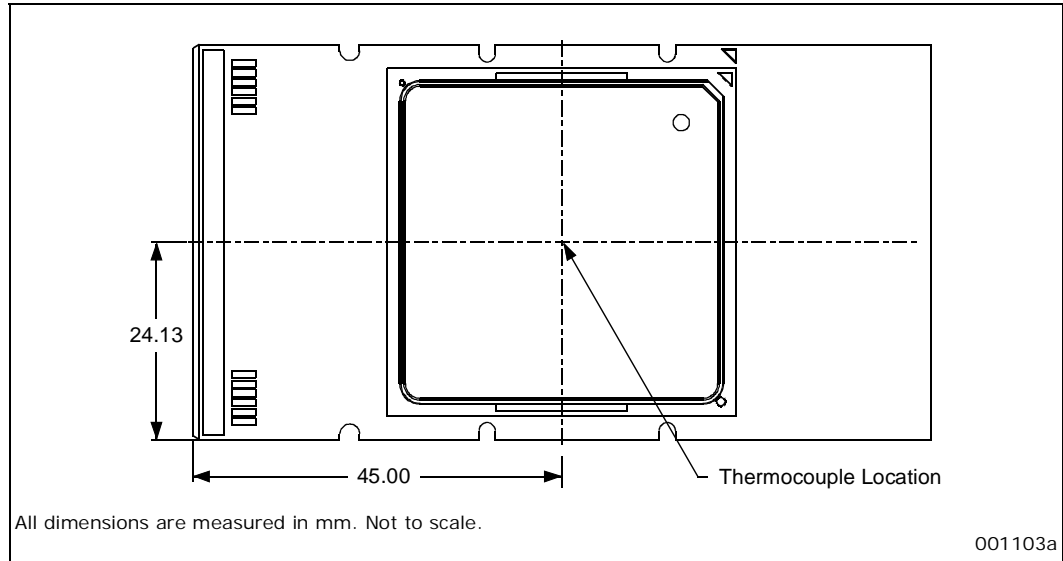

Table 5-1. Case Temperature Specification

Symbol	Parameter	Core Frequency	Minimum	Maximum	Unit	Notes
Tcase	Case Temperature	1.6GHz/24MB	5	76	°C	
		1.6GHz/18MB	5	76	°C	
		1.6GHz/9MB	5	76	°C	
		1.42GHz/12MB	5	76	°C	
		1.4GHz/12MB	5	76	°C	
		1.6GHz/6MB	5	74	°C	

Figure 5-2 contains dimensions for the thermocouple location on the processor package. This is the recommended location for placement of a thermocouple for case temperature measurement.

Figure 5-2. Itanium® Processor Package Thermocouple Location



§





6 System Management Feature Specifications

The Dual-Core Intel Itanium processor 9000 and 9100 series includes a system management bus (SMBus) interface. This chapter describes the features of the SMBus and SMBus components.

6.1 System Management Bus

6.1.1 System Management Bus Interface

The processor includes an Itanium processor family SMBus interface which allows access to several processor features. The system management components on the processor include two memory components (EEPROMs) and a thermal sensing device (digital thermometer). The processor information EEPROM (PIROM) is programmed by Intel with manufacturing and feature information specific to the Dual-Core Intel Itanium processor 9000 and 9100 series. This information is permanently write-protected. [Section 6.2](#) provides details on the PIROM. The other EEPROM is a scratch EEPROM that is available for other data at the system vendor's discretion. The thermal sensor can be used in conjunction with the information in the PIROM and/or the Scratch EEPROM for system thermal monitoring and management. The thermal sensing device on the processor provides an accurate means of acquiring an indicator of the junction temperature of the processor core die. The thermal sensing device is connected to the anode and cathode of the processor on-die thermal diode. SMBus implementation on the processor uses the clock and data signals as defined by SMBus specifications.

6.1.2 System Management Interface Signals

[Table 6-1](#) lists the system management interface signals and their descriptions. These signals are used by the system to access the system management components via the SMBus.

Table 6-1. System Management Interface Signal Descriptions

Signal Name	Pin Count	Description
3.3V	1	Voltage supply for EEPROMs and thermal sensor.
SMA[2:0]	3	Address select passed through from socket.
SMSC	1	System management bus clock.
SMSD	1	System management serial address/data bus.
SMWP	1	Scratch EEPROM write protect.
THRMALERT#	1	Temperature alert from the thermal sensor.

[Figure 6-1](#) shows the logical schematics of SMBus circuitry on the processor and shows how the various system management components are connected to the SMBus. The reference to the System Board at the lower left corner of [Figure 6-1](#) shows how SMBus address configuration for multiple processors can be realized with resistor stuffing options.

Figure 6-1. Logical Schematic of SMBus Circuitry

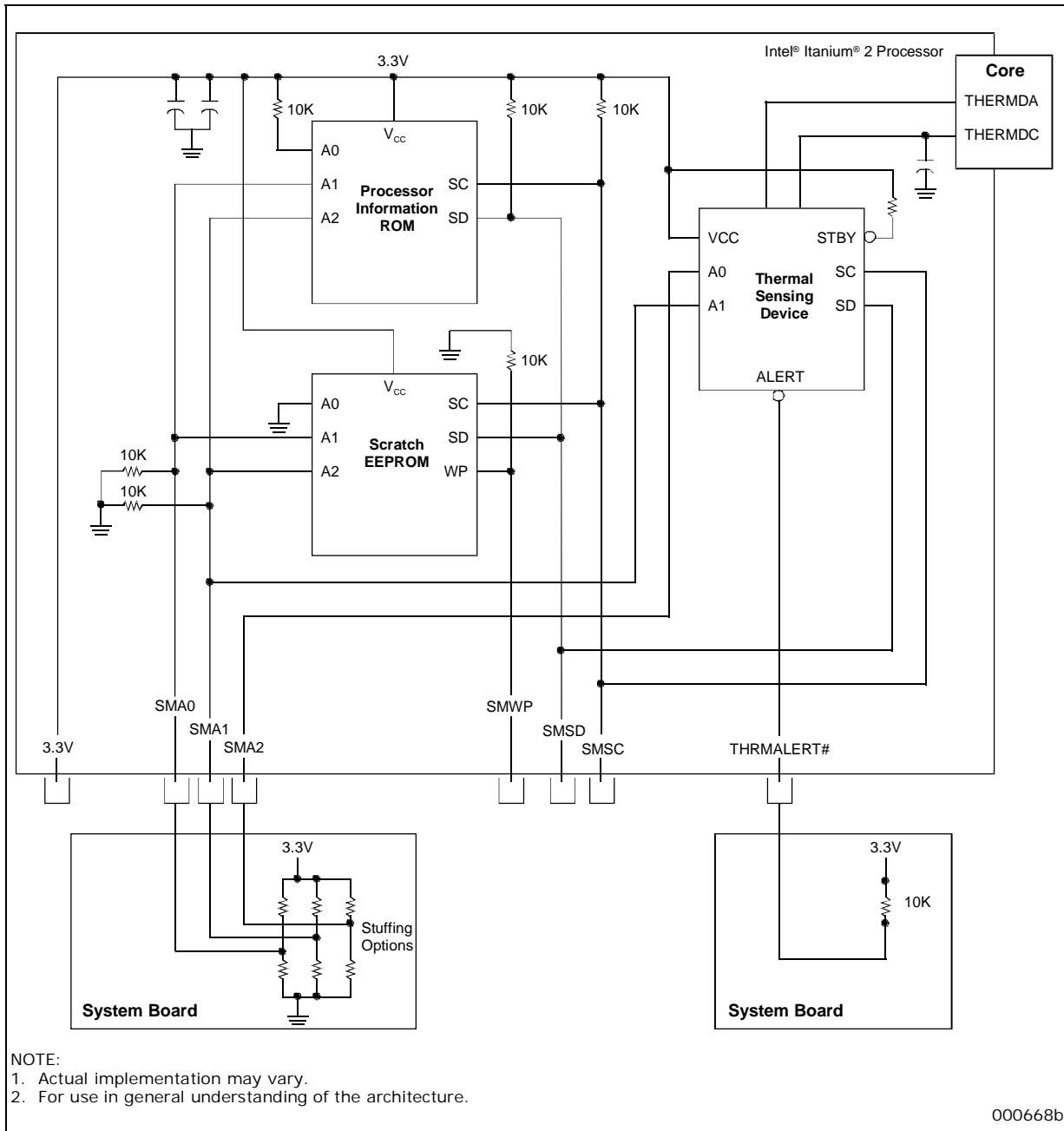



6.1.3 SMBus Device Addressing

Of the addresses broadcast across the SMBus, the memory components claim those of the form "1010XXYZb". The "XX" and "Y" bits are used to enable the devices on the processor at adjacent addresses. The Y bit is hard-wired on the processor to GND ('0') for the Scratch EEPROM and pulled to 3.3 V ('1') for the processor information ROM. The "XX" bits are defined by the processor socket via the SMA0 and SMA1 pins on the processor connector. These address pins have a weak pull-down (10 k Ω) to ensure that the memory components are in a known state in systems which do not support the SMBus, or only support a partial implementation. The "Z" bit is the read/write bit for the serial bus transaction.

The thermal sensing device internally decodes one of three upper address patterns from the bus of the form "0011XXXZb", "1001XXXZb" or "0101XXXZb". The device's addressing, as implemented, uses SMA2 and SMA1 and includes a Hi-Z state for the SMA2 address pin. Therefore, the thermal sensing device supports six unique resulting addresses. To set the Hi-Z state for SMA2, the pin must be left floating. The system should drive SMA1 and SMA0, and will be pulled low (if not driven) by the 10 k Ω pull-down resistor on the processor substrate. Attempting to drive either of these signals to a Hi-Z state would cause ambiguity in the memory device address decode, possibly resulting in the devices not responding, thus timing out or hanging the SMBus. As before, the "Z" bit is the read/write bit for the serial bus transaction.

Figure 6-1 shows a logical diagram of the pin connections. Table 6-2 and Table 6-3 describe the address pin connections and how they affect the addressing of the devices.

Note: Addresses of the form "0000XXXb" are Reserved and should not be generated by an SMBus master. Also, system management software must be aware of the processor select in the address for the thermal sensing device.

Table 6-2. Thermal Sensing Device SMBus Addressing on the Dual-Core Intel® Itanium® Processor 9000 and 9100 series

Address (Hex)	Upper Address ¹	Processor Select		8-Bit Address Word on Serial Bus
		SMA2	SMA1	b[7:0]
3Xh	0011	0	0	0011000Xb
	0011	0	1	0011010Xb
5Xh	0101	Z ²	0	0101001Xb
	0101	Z ^b	1	0101011Xb
9Xh	1001	1	0	1001100Xb
	1001	1	1	1001110Xb

Notes:

- Upper address bits are decoded in conjunction with the select pins.
- A tri-state or "Z" state on this pin is achieved by leaving this pin unconnected.



Table 6-3. EEPROM SMBus Addressing on the Dual-Core Intel® Itanium® Processor 9000 and 9100 Series

Address (Hex)	Upper Address ¹	Processor Select		Memory Device Select	Read/Write	Device Addressed
	Bits 7–4	(SMA1) Bit 3	(SMA0) Bit 2	Bit 1	Bit 0	
A0h/A1h	1010	0	0	0	X	Scratch EEPROM 1
A2h/A3h	1010	0	0	1	X	Processor Information ROM 1
A4h/A5h	1010	0	1	0	X	Scratch EEPROM 2
A6h/A7h	1010	0	1	1	X	Processor Information ROM 2
A8h/A9h	1010	1	0	0	X	Scratch EEPROM 3
AAh/ABh	1010	1	0	1	X	Processor Information ROM 3
ACh/ADh	1010	1	1	0	X	Scratch EEPROM 4
AEh/AFh	1010	1	1	1	X	Processor Information ROM 4

Notes:

1. Although this addressing scheme is targeted for up to four-way MP systems, more processors can be supported by using a multiplexed (or separate) SMBus implementation.

6.2 Processor Information ROM

An electrically programmed read-only memory (ROM) provides information about the processor. The checksum bits for each category provide error correction and serve as a mechanism to check whether data is corrupted or not. This information is permanently write-protected. Table 6-4 shows the data fields and formats provided in the memory.

Note: The data, in byte format, is written and read serially, with the most significant bit first.

Table 6-4. Processor Information ROM Format (Sheet 1 of 3)

Offset/Section	# of Bits	Function	Notes	Examples
Header				
00h	8	Data Format Revision	Two 4-bit hex digits	Start with 00h
01h	16	EEPROM Size	Size in bytes (MSB first)	Use a decimal to hex transfer; 128 bytes = 0080h: <ul style="list-style-type: none"> • 02h[7:4] = 0000 • 02h[3:0] = 0000 • 01h[7:4] = 1000 • 01h[3:0] = 0000
03h	8	Processor Data Address	Byte pointer, 00h if not present	0Eh
04h	8	Processor Core Address	Byte pointer, 00h if not present	17h
05h	8	Processor Cache Address	Byte pointer, 00h if not present	28h
06h	8	Processor Data Address	Byte pointer, 00h if not present	37h
07h	8	Part Number Data Address	Byte pointer, 00h if not present	3Eh
08h	8	Thermal Reference Data Address	Byte pointer, 00h if not present	63h
09h	8	Feature Data Address	Byte pointer, 00h if not present	67h
0Ah	8	Other Data Address	Byte pointer, 00h if not present	7Ah

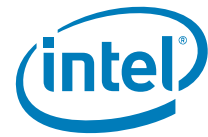

Table 6-4. Processor Information ROM Format (Sheet 2 of 3)

Offset/Section	# of Bits	Function	Notes	Examples
0Bh	16	Reserved	Reserved for future use	0000h
0Dh	8	Checksum	1 byte checksum	Add up by byte and take 2's complement.
Processor				
0Eh	48	S-spec Number	Six 8-bit ASCII characters	S-spec number of S123 would be: <ul style="list-style-type: none"> • 13h = 00h • 12h = 00h • 11h = "3" • 10h = "2" • 0Fh = "1" • 0Eh = "S"
14h	2	Sample/Production	00b = Sample only (MSB First)	00000001b = Production
15h	8	Reserved	Reserved for future use	00h
16h	8	Checksum	1 byte checksum	Add up by byte and take 2's complement.
Core				
17h	8	Architecture Revision	From CPUID ¹	Taken from CPUID[3].archrev.
18h	8	Processor Core Family	From CPUID	Taken from CPUID[3].family.
19h	8	Processor Core Model	From CPUID	Taken from CPUID[3].model.
1Ah	8	Processor Core Stepping	From CPUID	Taken from CPUID[3].revision.
1Bh	24	Reserved	Reserved for future use	000000h
1Eh	16	Maximum Core Frequency	Four 4-bit hex digits (in MHz)	1 GHz = 1000h ²
20h	12	Maximum System Bus Frequency	Three 4-bit hex digits (in MHz)	200 MHz = 200h ¹
22h	16	Core Voltage ID	Voltage in four 4-bit hex digits (in mV)	1500 mV = 1500h ¹
24h	8	Core Voltage Tolerance, High	Edge finger tolerance in mV, + two 4-bit hex digits	1.5% = 22 mV = 22h ¹
25h	8	Core Voltage Tolerance, Low	Edge finger tolerance in mV, - two 4-bit hex digits	1.5% = 22 mV = 22h ¹
26h	8	Reserved	Reserved for future use	00h
27h	8	Checksum	1 byte checksum	Add up by byte and take 2's complement.
Cache				
28h	32	Reserved	Reserved for future use	00000000h
2Ch	16	Cache Size	Four 4-bit hex digits (in Kbytes)	3072 Kbytes = 3072h ^{1,3}
2Eh	64	Reserved	Reserved for future use	x0h
36h	8	Checksum	1 byte checksum	
Package				
37h	32	Package Revision	Four 8-bit ASCII characters	NE: <ul style="list-style-type: none"> • 37h = N • 38h = E • 39h = 0 • 3Ah = 0
3Bh	2	Substrate Revision Software ID	2-bit revision number	00



Table 6-4. Processor Information ROM Format (Sheet 3 of 3)

Offset/Section	# of Bits	Function	Notes	Examples
3Ch	8	Reserved	Reserved for future use	00h
3Dh	8	Checksum	1 byte checksum	Add up by byte and take 2's complement
Part Numbers				
3Eh	56	Processor Part Number	Seven 8-bit ASCII characters	80549KC <ul style="list-style-type: none"> • 3Eh = "8" • 3Fh = "0" • 40h = "5" • 41h = "4" • 42h = "2" • 43h = "K" • 44h = "C"
45h	64	Processor Electronic Signature	64-bit identification number	May have padded zeros
4Dh	168	Reserved	Reserved for future use	x0h
62h	8	Checksum	1 byte checksum	Add up by byte and take 2's complement
Thermal Reference				
63h	8	Upper Temp Reference Byte	Hex value of thermal upper temp limit	Default = 92 = 5Ch
64h	8	Thermal Calibration Offset Byte Present	Number of degrees in error (\pm)	will be set per part and expected to be $\sim +12C$
65h	8	Reserved	Reserved for future use	00h
66h	8	Checksum	1 byte checksum	Add up by byte and take 2's complement.
Features				
67h	32	IA-32 Processor Core Feature Flags	From 32 bit CPUID	4387FBFFh
6Bh	64	Reserved	Reserved (Processor core feature flags implemented in the Itanium [®] processor family)	0000 0000 6380 811Bh
73h	32	Processor Feature Flags	All others are reserved: [9] = Demand Based Switching Enabled [8] = Core Level Lockstep Enabled [7] = Socket Level Lockstep Enabled [6] = Dual Core Enabled [5] = Hyper-Threading Enabled [4] = Upper temp reference byte [3] = Thermal calibration offset byte present [2] = Scratch EERPOM present [1] = Core VID Present	1 indicates EEPROM data for specified field is valid.
77h	4	Number of Devices in TAP Chain	One 4-bit hex digit	2h for dual-core processor
78h	4	Reserved	Reserved for future use	0h
79h	8	Checksum	1 byte checksum	Add up by byte and take 2's complement.
Other				
7Ah	16	Reserved	Reserved for future use	0000h

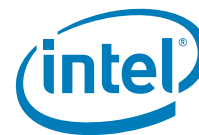
**Notes:**

1. Refer to the *Intel® Itanium™ Architecture Software Developer's Manual* for details on CPUID registers.
2. The translation is using BCD.
3. Itanium 9000 and 9100 series use a hex-to-decimal conversion

6.3 Scratch EEPROM

Also available on the SMBus interface on the processor is an EEPROM which may be used for other data at the system vendor's discretion (Intel will not be using the scratch EEPROM). The data in this EEPROM, once programmed, can be write-protected by asserting the active-high SMWP signal. This signal has a weak pull-down (10 k Ω) to allow the EEPROM to be programmed in systems with no implementation of this signal.

6.4 Processor Information ROM and Scratch EEPROM Supported SMBus Transactions

The processor information ROM and scratch EEPROM responds to three of the SMBus packet types: current address read, random address read, and sequential read.

Table 6-5 shows the format of the current address read SMBus packet. The internal address counter keeps track of the address accessed during the last read or write operation, incremented by one. Address "roll over" during reads is from the last byte of the last eight byte page to the first byte of the first page. "Roll over" during writes is from the last byte of the current eight byte page to the first byte of the same page.

Table 6-6 shows the format of the random read SMBus packet. The write with no data loads the address desired to be read. Sequential reads may begin with a current address read or a random address read. After the SMBus host controller receives the data word, it responds with an acknowledge. This will continue until the SMBus host controller responds with a negative acknowledge and a stop.

Table 6-7 shows the format of the byte write SMBus packet. The page write operates the same way as the byte write, except that the SMBus host controller does not send a stop after the first data byte and acknowledge. The Scratch EEPROM internally increments its address. The SMBus host controller continues to transmit data bytes until it terminates the sequence with a stop. All data bytes will result in an acknowledge from the Scratch EEPROM. If more than eight bytes are written, the internal address will "roll over" and the previous data will be overwritten.

In Table 6-5 through Table 6-7, 'S' represents the SMBus start bit, 'P' represents a stop bit, 'R' represents a read, 'W' represents a write bit, 'A' represents an acknowledge, and '///' represents a negative acknowledge. The shaded bits are transmitted by the processor information ROM or Scratch EEPROM and the bits that are not shaded are transmitted by the SMBus host controller. In the tables, the data addresses indicate eight bits. The SMBus host controller should transmit eight bits, but as there are only 128 addresses, the most significant bit is a don't care.

Table 6-5. Current Address Read SMBus Packet

S	Device Address	R	A	Data	///	P
1	7 bits	1	1	8 bits	1	1



Table 6-6. Random Address Read SMBus Packet

S	Device Address	W	A	Data Address	A	S	Device Address	R	A	Data	///	P
1	7 bits	1	1	8 bits	1	1	7 bits	1	1	8 bits	1	1

Table 6-7. Byte Write SMBus Packet

S	Device Address	W	A	Data Address	A	Data	A	P
1	7 bits	0	1	8 bits	1	8 bits	1	1

6.5 Thermal Sensing Device

The Dual-Core Intel Itanium processor 9000 and 9100 series thermal sensing device provides a means of acquiring thermal data from the processor. The accuracy of the thermal reading is expected to be better than ± 5 °C. The thermal sensing device is composed of control logic, SMBus interface logic, a precision analog to digital converter, and a precision current source. The thermal sensing device drives a small current through a thermal diode located on the processor core and measures the voltage generated across the thermal diode by the current. With this information, the thermal sensing device computes a byte of temperature data. Software running on the processor or on a micro-controller can use the temperature data from the thermal sensing device to thermally manage the system.

The thermal sensing device provides a register with a data byte (seven bits plus sign) which contains a value corresponding to the sampled output of the thermal diode in the processor core. The value of the byte read from the thermal sensor is always higher than the actual processor core temperature; therefore, the offset from the reading needs to be subtracted to obtain an accurate reading of the processor core temperature. This data can be used in conjunction with the upper temperature reference byte (provided in the Processor Information ROM) for thermal management purposes. The temperature data from the thermal sensor can be read out digitally using an SMBus read command (see [Section 6.6](#)). The thermal sensor detects when SMBus power is applied to the processor, and resets itself at power-up.

The thermal sensing device also contains alarm registers to store thermal reference threshold data. These values can be individually programmed on the thermal sensor. If the measured temperature equals or exceeds the alarm threshold value, the appropriate bit is set in the thermal sensing device status register, which is also brought out to the processor system bus via the THRMALERT# signal (see [Section 6.1.1](#) for more details). At power-up, the appropriate alarm register values need to be programmed into the thermal sensing device via the SMBus. It is recommended that the upper thermal reference threshold byte (provided in the processor information ROM) be used for setting the upper threshold value in the alarm register. To account for the offset inherent in the thermal sensing device reading, the actual programmed value of the upper threshold value in the alarm register should be the sum of the upper thermal reference threshold byte and the thermal calibration offset byte (both provided in the PIROM).

When polling the thermal sensing device on the processor to read the processor temperatures, it is recommended that the polling frequency be every 0.5 to 1 second.



6.6 Thermal Sensing Device Supported SMBus Transactions

The thermal sensing device responds to five of the SMBus packet types: write byte, read byte, send byte, receive byte, and alert response address (ARA). The send byte packet is used for sending one-shot commands only. The receive byte packet accesses the register commanded by the last read byte packet. If a receive byte packet was preceded by a write byte or send byte packet more recently than a read byte packet, then the behavior is undefined. Table 6-8 through Table 6-12 diagram the five packet types. In these tables, 'S' represents the SMBus start bit, 'P' represents a stop bit, 'Ack' represents an acknowledge, and '///' represents a negative acknowledge. The shaded bits are transmitted by the thermal sensor and the unshaded bits are transmitted by the SMBus host controller. Table 6-13 shows the encoding of the command byte.

Table 6-8. Write Byte SMBus Packet

S	Address	Write	Ack	Command	Ack	Data	Ack	P
1	7 bits	1	1	8 bits	1	8 bits	1	1

Table 6-9. Read Byte SMBus Packet

S	Address	Write	Ack	Command	Ack	S	Address	Read	Ack	Data	///	P
1	7 bits	0	1	8 bits	1	1	7 bits	1	1	8 bits	1	1

Table 6-10. Send Byte SMBus Packet

S	Address	Write	Ack	Command	Ack	P
1	7 bits	1	1	8 bits	1	

Table 6-11. Receive Byte SMBus Packet

S	Address	Read	Ack	Data	///	P
1	7 bits	1	1	8 bits	1	1

Table 6-12. ARA SMBus Packet

S	ARA	Read	Ack	Address	///	P
1	0001 100	1	1	1001 1011	1	1

Table 6-13. Command Byte Bit Assignment

Register	Command	Reset State	Function
RESERVED	00h	N/A	Reserved for future use.
RRT	01h	N/A	Read processor core thermal data.
RS	02h	N/A	Read status byte (flags, busy signal).
RC	03h	0000 0000	Read configuration byte.
RCR	04h	0000 0010	Read conversion rate byte.
RESERVED	05h	0111 1111	Reserved for future use.
RESERVED	06h	1100 1001	Reserved for future use.
RRHL	07h	0111 1111	Read processor core thermal diode T _{HIGH} limit.
RRLL	08h	1100 1001	Read processor core thermal diode T _{LOW} limit.
WC	09h	N/A	Write configuration byte.
WCR	0Ah	N/A	Write conversion rate byte.
RESERVED	0Bh	N/A	Reserved for future use.
RESERVED	0Ch	N/A	Reserved for future use.
WRHL	0Dh	N/A	Write processor core thermal diode T _{HIGH} limit.
WRLL	0Eh	N/A	Write processor core thermal diode T _{LOW} limit.
OSHT	0Fh	N/A	One shot command (use send byte packet).
RESERVED	10h – FFh	N/A	Reserved for future use.

All of the commands are for reading or writing registers in the thermal sensor except the one-shot command (OSHT). The one-shot command forces the immediate start of a new voltage-to-temperature conversion cycle. If a conversion is in progress when the one-shot command is received, then the command is ignored. If the thermal sensing device is in standby mode when the one-shot command is received, a conversion is performed and the sensor returns to standby mode. If the thermal sensor is in auto-convert mode and is between conversions, then the conversion rate timer resets, and the next automatic conversion takes place after a full delay elapses. Please refer to [Section 6.7.4](#) for further detail on standby and auto-convert modes.

The default command after reset is the reserved value (00h). After reset, receive byte packets will return invalid data until another command is sent to the thermal sensing device.

6.7 Thermal Sensing Device Registers

The system management software can configure and control the thermal sensor by writing to and interacting with different registers in the thermal sensor. These registers include a thermal reference register, two thermal limit registers, a status register, a configuration register, a conversion rate register, and other reserved registers. The following subsections describe the registers in detail.

6.7.1 Thermal Reference Registers

The processor core and thermal sensing device internal thermal reference registers contain the thermal reference value of the thermal sensing device and the processor core thermal diodes. This value ranges from +127 to –128 decimal and is expressed as a two's complement, eight-bit number. These registers are saturating, that is, values above 127 are represented at 127 decimal, and values below –128 are represented as –128 decimal.

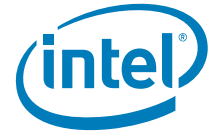

6.7.2 Thermal Limit Registers

The thermal sensing device has two thermal limit registers; they define high and low limits for the processor core thermal diode. The encoding for these registers is the same as for the thermal reference registers. If the diode thermal value equals or exceeds one of its limits, then its alarm bit in the status register is triggered. This indication is also brought out to the processor system bus via the THRMALERT# signal.

6.7.3 Status Register

The status register shown in [Table 6-14](#) indicates which (if any) of the thermal value thresholds have been exceeded. It also indicates if a conversion is in progress or if an open circuit has been detected in the processor core thermal diode connection. Once set, alarm bits stay set until they are cleared by a status register read. A successful read to the status register will clear any alarm bits that may have been set, unless the alarm condition persists. Note that the THRMALERT# interrupt signal is latched and is not automatically cleared when the status flag bit is cleared. The latch is cleared by sending the Alert Response Address (0001100) on the SMBus.

Table 6-14. Thermal Sensing Device Status Register

Bit	Name	Function
7 (MSB)	BUSY	A one indicates that the device's analog to digital converter is busy converting.
6	RESERVED	Reserved for future use.
5	RESERVED	Reserved for future use.
4	RHIGH	A one indicates that the processor core thermal diode high temperature alarm has been activated.
3	RLOW	A one indicates that the processor core thermal diode low temperature alarm has been activated.
2	OPEN	A one indicates an open fault in the connection to the processor core diode.
1	RESERVED	Reserved for future use.
0 (LSB)	RESERVED	Reserved for future use.

6.7.4 Configuration Register

The configuration register controls the operating mode (standby vs. auto-convert) of the thermal sensing device. [Table 6-15](#) shows the format of the configuration register. If the RUN/STOP bit is set (high) then the thermal sensing device immediately stops converting and enters standby mode. The thermal sensing device will still perform analog-to-digital conversions in standby mode when it receives a one-shot command. If the RUN/STOP bit is clear (low) then the thermal sensor enters auto-conversion mode. The thermal sensing device starts operating in free running mode, auto-converting at 0.25 Hz after power-up.

Table 6-15. Thermal Sensing Device Configuration Register

Bit	Name	Reset State	Function
7 (MSB)	RESERVED	0	Reserved for future use.
6	RUN/STOP	0	Standby mode control bit. If high, the device immediately stops converting, and enters standby mode. If low, the device converts in either one-shot or timer mode.
5-0	RESERVED	0	Reserved for future use.

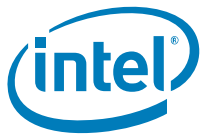

6.7.5 Conversion Rate Register

The contents of the conversion rate register determine the nominal rate at which analog-to-digital conversions happen when the thermal sensing device is in auto-convert mode. Table 6-16 shows the mapping between conversion rate register values and the conversion rate. As indicated in Table 6-16, the conversion rate register is set to its default state of 02h (0.25 Hz nominally) when the thermal sensing device is powered-up. There is a $\pm 25\%$ error tolerance between the conversion rate indicated in the conversion rate register and the actual conversion rate.

Table 6-16. Thermal Sensing Device Conversion Rate Register

Register Contents	Conversion Rate (Hz)
00h	0.0625
01h	0.125
02h	0.25
03h	0.5
04h	1
05h	2
06h	4
07h	8
08h to FFh	Reserved for future use

§



A Signals Reference

This appendix provides an alphabetical listing of all Dual-Core Intel Itanium 9000 and 9100 series processor system bus signals. The tables at the end of this appendix summarize the signals by direction: output, input, and I/O.

For a complete pinout listing including processor specific pins, please refer to [Chapter 3, "Pinout Specifications."](#)

A.1 Alphabetical Signals Reference

A.1.1 A[49:3]# (I/O)

The Address (A[49:3]#) signals, with byte enables, define a 2⁵⁰ Byte physical memory address space. When ADS# is active, these pins transmit the address of a transaction. These pins are also used to transmit other transaction related information such as transaction identifiers and external functions in the cycle following ADS# assertion. These signals must connect the appropriate pins of all agents on the processor system bus. The A[49:27]# signals are parity-protected by the AP1# parity signal, and the A[26:3]# signals are parity-protected by the AP0# parity signal.

On the active-to-inactive transition of RESET#, the processors sample the A[49:3]# pins to determine their power-on configuration.

A.1.2 A20M# (I)

A20M# is no connect and is ignored in the processor system environment.

A.1.3 ADS# (I/O)

The Address Strobe (ADS#) signal is asserted to indicate the validity of the transaction address on the A[49:3]#, REQ[5:0]#, AP[1:0]# and RP# pins. All bus agents observe the ADS# activation to begin parity checking, protocol checking, address decode, internal snoop, or deferred reply ID match operations associated with the new transaction.

A.1.4 AP[1:0]# (I/O)

The Address Parity (AP[1:0]#) signals can be driven by the request initiator along with ADS# and A[49:3]#. AP[1]# covers A[49:27]#, and AP[0]# covers A[26:3]#. A correct parity signal is high if an even number of covered signals are low and low if an odd number of covered signals are low. This allows parity to be high when all the covered signals are high.

A.1.5 ASZ[1:0]# (I/O)

The ASZ[1:0]# signals are the memory address-space size signals. They are driven by the request initiator during the first Request Phase clock on the REQa[4:3]# pins. The ASZ[1:0]# signals are valid only when REQa[2:1]# signals equal 01B, 10B, or 11B, indicating a memory access transaction. The ASZ[1:0]# decode is defined in [Table A-1](#).

Table A-1. Address Space Size

ASZ[1:0]#		Memory Address Space	Memory Access Range
0	0	Reserved	Reserved
0	1	36-bit	0 to (64 GByte - 1)
1	0	50-bit	64 GByte to (1 Pbyte -1)
1	1	Reserved	Reserved

Any memory access transaction addressing a memory region that is less than 64 GB (that is, Aa[49:36]# are all zeroes) must set ASZ[1:0]# to 01. Any memory access transaction addressing a memory region that is equal to or greater than 64 GB (that is, Aa[49:36]# are not all zeroes) must set ASZ[1:0]# to 10. All observing bus agents that support the 64 GByte (36-bit) address space must respond to the transaction when ASZ[1:0]# equals 01. All observing bus agents that support larger than the 64 GByte (36-bit) address space must respond to the transaction when ASZ[1:0]# equals 01 or 10.

A.1.6 ATTR[3:0]# (I/O)

The ATTR[3:0]# signals are the attribute signals. They are driven by the request initiator during the second clock of the Request Phase on the Ab[35:32]# pins. The ATTR[3:0]# signals are valid for all transactions. The ATTR[3]# signal is reserved. The ATTR[2:0]# are driven based on the memory type. Please refer to [Table A-2](#).

Table A-2. Effective Memory Type Signal Encoding

ATTR[2:0]#	Description
000	Uncacheable
100	Write Coalescing
101	Write-Through
110	Write-Protect
111	Writeback

A.1.7 BCLKp/BCLKn (I)

The BCLKp and BCLKn differential clock signals determine the bus frequency. All agents drive their outputs and latch their inputs on the differential crossing of BCLKp and BCLKn on the signals that are using the common clock latched protocol.

BCLKp and BCLKn indirectly determine the internal clock frequency of the processor. Each processor derives its internal clock by multiplying the BCLKp and BCLKn frequency by a ratio that is defined and allowed by the power-on configuration.

A.1.8 BE[7:0]# (I/O)

The BE[7:0]# signals are the byte-enable signals for partial transactions. They are driven by the request initiator during the second Request Phase clock on the Ab[15:8]# pins.

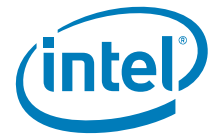

For memory or I/O transactions, the byte-enable signals indicate that valid data is requested or being transferred on the corresponding byte on the 128-bit data bus. BE[0]# indicates that the least significant byte is valid, and BE[7]# indicates that the most significant byte is valid. Since BE[7:0]# specifies the validity of only 8 bytes on the 16 byte wide bus, A[3]# is used to determine which half of the data bus is validated by BE[7:0]#.

For special transactions ((REQa[5:0]# = 001000B) and (REQb[1:0]# = 01B)), the BE[7:0]# signals carry special cycle encodings as defined in Table A-3. All other encodings are reserved.

Table A-3. Special Transaction Encoding on Byte Enables

Special Transaction	Byte Enables[7:0]#
NOP	0000 0000
Shutdown	0000 0001
Flush (INVD)	0000 0010
Halt	0000 0011
Sync (WBINVD)	0000 0100
Reserved	0000 0101
StopGrant Acknowledge	0000 0110
Reserved	0000 0111
xTPR Update	0000 1000

For Deferred Reply transactions, BE[7:0]# signals are reserved. The Defer Phase transfer length is always the same length as that specified in the Request Phase except the Bus Invalidate Line (BIL) transaction.

A BIL transaction may return one cache line (128 bytes).

A.1.9 BERR# (I/O)

The Bus Error (BERR#) signal can be asserted to indicate a recoverable error with global MCA. BERR# assertion conditions are configurable at the system level. Configuration options enable BERR# to be driven as follows:

- Asserted by the requesting agent of a bus transaction after it observes an internal error.
- Asserted by any bus agent when it observes an error in a bus transaction.

When the bus agent samples an asserted BERR# signal and BERR# sampling is enabled, the processor enters a Machine Check Handler.

BERR# is a wired-OR signal to allow multiple bus agents to drive it at the same time.



A.1.10 **BINIT# (I/O)**

If enabled by configuration, the Bus Initialization (BINIT#) signal is asserted to signal any bus condition that prevents reliable future operation.

If BINIT# observation is enabled during power-on configuration, and BINIT# is sampled asserted, all bus state machines are reset. All agents reset their rotating IDs for bus arbitration to the same state as that after reset, and internal count information is lost. The L2 and L3 caches are not affected.

If BINIT# observation is disabled during power-on configuration, BINIT# is ignored by all bus agents with the exception of the priority agent. The priority agent must handle the error in a manner that is appropriate to the system architecture.

BINIT# is a wired-OR signal.

A.1.11 **BNR# (I/O)**

The Block Next Request (BNR#) signal is used to assert a bus stall by any bus agent that is unable to accept new bus transactions to avoid an internal transaction queue overflow. During a bus stall, the current bus owner cannot issue any new transactions.

Since multiple agents might need to request a bus stall at the same time, BNR# is a wired-OR signal. In order to avoid wired-OR glitches associated with simultaneous edge transitions driven by multiple drivers, BNR# is asserted and sampled on specific clock edges.

A.1.12 **BPM[5:0]# (I/O)**

The BPM[5:0]# signals are system support signals used for inserting breakpoints and for performance monitoring. They can be configured as outputs from the processor that indicate programmable counters used for monitoring performance, or inputs from the processor to indicate the status of breakpoints.

A.1.13 **BPRI# (I)**

The Bus Priority-agent Request (BPRI#) signal is used by the priority agent to arbitrate for ownership of the system bus. Observing BPRI# asserted causes all other agents to stop issuing new requests, unless such requests are part of an ongoing locked operation. The priority agent keeps BPRI# asserted until all of its requests are completed, then releases the bus by deasserting BPRI#.

A.1.14 **BR[0]# (I/O) and BR[3:1]# (I)**

BR[3:0]# are the physical bus request pins that drive the BREQ[3:0]# signals in the system. The BREQ[3:0]# signals are interconnected in a rotating manner to individual processor pins. [Table A-4](#) and [Table A-4](#) give the rotating interconnection between the processor and bus signals for both the 4P and 2P system bus topologies.



Table A-4. BR0# (I/O), BR1#, BR2#, BR3# Signals for 4P Rotating Interconnect

Bus Signal	Agent 0 Pins	Agent 1 Pins	Agent 2 Pins	Agent 3 Pins
BREQ[0]#	BR[0]#	BR[3]#	BR[2]#	BR[1]#
BREQ[1]#	BR[1]#	BR[0]#	BR[3]#	BR[2]#
BREQ[2]#	BR[2]#	BR[1]#	BR[0]#	BR[3]#
BREQ[3]#	BR[3]#	BR[2]#	BR[1]#	BR[0]#

Table A-5. BR0# (I/O), BR1#, BR2#, BR3# Signals for 2P Rotating Interconnect

Bus Signal	Agent 0 Pins	Agent 3 Pins
BREQ[0]#	BR[0]#	BR[1]#
BREQ[1]#	BR[1]#	BR[0]#
BREQ[2]#	Not Used	Not Used
BREQ[3]#	Not Used	Not Used

During power-on configuration, the priority agent must assert the BR[0]# bus signal. All symmetric agents sample their BR[3:0]# pins on asserted-to-deasserted transition of RESET#. The pin on which the agent samples an asserted level determines its agent ID. All agents then configure their pins to match the appropriate bus signal protocol as shown in Table A-6.

Table A-6. BR[3:0]# Signals and Agent IDs

Pin Sampled Asserted on RESET#	Arbitration ID	Agent ID Reported
BR[0]#	0	0
BR[3]#	1	2
BR[2]#	2	4
BR[1]#	3	6

A.1.15 BREQ[3:0]# (I/O)

The BREQ[3:0]# signals are the symmetric agent arbitration bus signals (called bus request). A symmetric agent *n* arbitrates for the bus by asserting its BREQ_{*n*}# signal. Agent *n* drives BREQ_{*n*}# as an output and receives the remaining BREQ[3:0]# signals as inputs.

The symmetric agents support distributed arbitration based on a round-robin mechanism. The rotating ID is an internal state used by all symmetric agents to track the agent with the lowest priority at the next arbitration event. At power-on, the rotating ID is initialized to three, allowing agent 0 to be the highest priority symmetric agent. After a new arbitration event, the rotating ID of all symmetric agents is updated to the agent ID of the symmetric owner. This update gives the new symmetric owner lowest priority in the next arbitration event.

A new arbitration event occurs either when a symmetric agent asserts its BREQ_{*n*}# on an Idle bus (all BREQ[3:0]# previously deasserted), or the current symmetric owner deasserts BREQ_{*n*}# to release the bus ownership to a new bus owner *n*. On a new arbitration event, all symmetric agents simultaneously determine the new symmetric owner using BREQ[3:0]# and the rotating ID. The symmetric owner can park on the bus (hold the bus) provided that no other symmetric agent is requesting its use. The symmetric owner parks by keeping its BREQ_{*n*}# signal asserted. On sampling BREQ_{*n*}# asserted by another symmetric agent, the symmetric owner deasserts BREQ_{*n*}# as soon as possible to release the bus. A symmetric owner stops issuing new requests that are not part of an existing locked operation on observing BPRI# asserted.

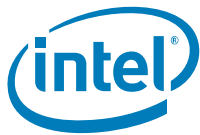

A symmetric agent can deassert $BREQn\#$ before it becomes a symmetric owner. A symmetric agent can reassert $BREQn\#$ after keeping it deasserted for one clock.

A.1.16 CCL# (I/O)

CCL# is the Cache Cleanse signal. It is driven on the second clock of the Request Phase on the EXF[2]#/Ab[5]# pin. CCL# is asserted for Memory Write transaction to indicate that a modified line in a processor may be written to memory without being invalidated in its caches.

A.1.17 CPUPRES# (O)

CPUPRES# can be used to detect the presence of a processor in a socket. A ground indicates that a processor is installed, while an open indicates that a processor is not installed.

A.1.18 D[127:0]# (I/O)

The Data (D[127:0]#) signals provide a 128-bit data path between various system bus agents. Partial transfers require one data transfer clock with valid data on the byte(s) indicated by asserted byte enables BE[7:0]# and A[3]#. Data signals that are not valid for a particular transfer must still have correct ECC (if data bus error checking is enabled). The data driver asserts DRDY# to indicate a valid data transfer.

A.1.19 D/C# (I/O)

The Data/Code (D/C#) signal is used to indicate data (1) or code (0) on REQa[1]#, only during Memory Read transactions.

A.1.20 DBSY# (I/O)

The Data Bus Busy (DBSY#) signal is asserted by the agent that is responsible for driving data on the system bus to indicate that the data bus is in use. The data bus is released after DBSY# is deasserted.

DBSY# is replicated three times to enable partitioning of the data paths in the system agents. This copy of the Data Bus Busy signal (DBSY#) is an input as well as an output.

A.1.21 DBSY_C1# (O)

DBSY# is a copy of the Data Bus Busy signal. This copy of the Data Bus Busy signal (DBSY_C1#) is an output only.

A.1.22 DBSY_C2# (O)

DBSY# is a copy of the Data Bus Busy signal. This copy of the Data Bus Busy signal (DBSY_C2#) is an output only.

A.1.23 DEFER# (I)

The DEFER# signal is asserted by an agent to indicate that the transaction cannot be guaranteed in-order completion. Assertion of DEFER# is normally the responsibility of the priority agent.



A.1.24 DEN# (I/O)

The Defer Enable (DEN#) signal is driven on the bus on the second clock of the Request Phase on the Ab[4]# pin. DEN# is asserted to indicate that the transaction can be deferred by the responding agent.

A.1.25 DEP[15:0]# (I/O)

The Data Bus ECC Protection (DEP[15:0]#) signals provide optional ECC protection for Data Bus (D[127:0]#). They are driven by the agent responsible for driving D[127:0]#. During power-on configuration, bus agents can be enabled for either ECC checking or no checking.

The ECC error correcting code can detect and correct single-bit errors and detect double-bit or nibble errors.

A.1.26 DHIT# (I)

The Deferred Hit (DHIT#) signal is driven during the Deferred Phase by the deferring agent. For read transactions on the bus DHIT# returns the final cache status that would have been indicated on HIT# for a transaction which was not deferred. DID[9:0]# (I/O)

DID[9:0]# are Deferred Identifier signals. The requesting agent transfers these signals by using A[25:16]#. They are transferred on Ab[25:16]# during the second clock of the Request Phase on all transactions, but Ab[20:16]# is only defined for deferrable transactions (DEN# asserted). DID[9:0]# is also transferred on Aa[25:16]# during the first clock of the Request Phase for Deferred Reply transactions.

The Deferred Identifier defines the token supplied by the requesting agent. DID[9]# and DID[8:5]# carry the agent identifiers of the requesting agents (always valid) and DID[4:0]# carry a transaction identifier associated with the request (valid only with DEN# asserted). This configuration limits the bus specification to 32 logical bus agents with each one of the bus agents capable of making up to 32 requests. Table A-7 shows the DID encodings.

Table A-7. DID[9:0]# Encoding

DID[9]#	DID[8:5]#	DID[4:0]#
Agent Type	Agent ID[3:0]	Transaction ID[4:0]

DID[9]# indicates the agent type. Symmetric agents use 0. Priority agents use 1. DID[8:5]# indicates the agent ID. Symmetric agents use their arbitration ID. DID[4:0]# indicates the transaction ID for an agent. The transaction ID must be unique for all deferrable transactions issued by an agent which have not reported their snoop results.

The Deferred Reply agent transmits the DID[9:0]# (Ab[25:16]#) signals received during the original transaction on the Aa[25:16]# signals during the Deferred Reply transaction. This process enables the original requesting agent to make an identifier match with the original request that is awaiting completion.

**A.1.27 DPS# (I/O)**

The Deferred Phase Enable (DPS#) signal is driven to the bus on the second clock of the Request Phase on the Ab[3]# pin. DPS# is asserted if a requesting agent supports transaction completion using the Deferred Phase. A requesting agent that supports the Deferred Phase will always assert DPS#. A requesting agent that does not support the Deferred Phase will always deassert DPS#.

A.1.28 DRDY# (I/O)

The Data Ready (DRDY#) signal is asserted by the data driver on each data transfer, indicating valid data on the data bus. In a multi-cycle data transfer, DRDY# can be deasserted to insert idle clocks.

DRDY# is replicated three times to enable partitioning of data paths in the system agents. This copy of the Data Ready signal (DRDY#) is an input as well as an output.

A.1.29 DRDY_C1# (O)

DRDY# is a copy of the Data Ready signal. This copy of the Data Phase data-ready signal (DRDY_C1#) is an output only.

A.1.30 DRDY_C2# (O)

DRDY# is a copy of the Data Ready signal. This copy of the Data Phase data-ready signal (DRDY_C2#) is an output only.

A.1.31 DSZ[1:0]# (I/O)

The Data Size (DSZ[1:0]#) signals are transferred on REQb[4:3]# signals in the second clock of the Request Phase by the requesting agent. The DSZ[1:0]# signals define the data transfer capability of the requesting agent. For the processor, DSZ# = 01, always.

A.1.32 EXF[4:0]# (I/O)

The Extended Function (EXF[4:0]#) signals are transferred on the A[7:3]# pins by the requesting agent during the second clock of the Request Phase. The signals specify any special functional requirement associated with the transaction based on the requestor mode or capability. The signals are defined in [Table A-8](#).

Table A-8. Extended Function Signals

Extended Function Signal	Signal Name Alias	Function
EXF[4]#	Reserved	Reserved
EXF[3]#	SPLCK#/FCL#	Split Lock / Flush Cache Line
EXF[2]#	OWN#/CCL#	Memory Update Not Needed / Cache Cleanse
EXF[1]#	DEN#	Defer Enable
EXF[0]#	DPS#	Deferred Phase Supported

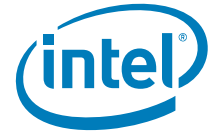
**A.1.33 FCL# (I/O)**

The Flush Cache Line (FCL#) signal is driven to the bus on the second clock of the Request Phase on the A[6]# pin. FCL# is asserted to indicate that the memory transaction is initiated by the global Flush Cache (FC) instruction.

A.1.34 FERR# (O)

The FERR# signal may be asserted to indicate a processor detected error when IERR mode is enabled. If IERR mode is disabled, the FERR# signal will not be asserted in the processor system environment.

A.1.35 GSEQ# (I)

Assertion of the Guaranteed Sequentiality (GSEQ#) signal indicates that the platform guarantees completion of the transaction without a retry while maintaining sequentiality.

A.1.36 HIT# (I/O) and HITM# (I/O)

The Snoop Hit (HIT#) and Hit Modified (HITM#) signals convey transaction snoop operation results. Any bus agent can assert both HIT# and HITM# together to indicate that it requires a snoop stall. The stall can be continued by reasserting HIT# and HITM# together.

A.1.37 ID[9:0]# (I)

The Transaction ID (ID[9:0]#) signals are driven by the deferring agent. The signals in the two clocks are referenced IDa[9:0]# and IDb[9:0]#. During both clocks, ID[9:0]# signals are protected by the IPO# parity signal for the first clock, and by the IP[1]# parity signal on the second clock.

IDa[9:0]# returns the ID of the deferred transaction which was sent on Ab[25:16]# (DID[9:0]#).

A.1.38 IDS# (I)

The ID Strobe (IDS#) signal is asserted to indicate the validity of ID[9:0]# in that clock and the validity of DHIT# and IP[1:0]# in the next clock.

A.1.39 IGNNE# (I)

IGNNE# is no connect and is ignored in the processor system environment.

A.1.40 INIT# (I)

The Initialization (INIT#) signal triggers an unmasked interrupt to the processor. INIT# is usually used to break into hanging or idle processor states. Semantics required for platform compatibility are supplied in the PAL firmware interrupt service routine.

A.1.41 INT (I)

INT is the 8259-compatible Interrupt Request signal which indicates that an external interrupt has been generated. The interrupt is maskable. The processor vectors to the interrupt handler after the current instruction execution has been completed. An interrupt acknowledge transaction is generated by the processor to obtain the interrupt vector from the interrupt controller.

The LINT[0] pin can be software configured to be used either as the INT signal or another local interrupt.

A.1.42 IP[1:0]# (I)

The ID Parity (IP[1:0]#) signals are driven on the second clock of the Deferred Phase by the deferring agent. IP0# protects the IDa[9:0]# and IDS# signals for the first clock, and IP[1]# protects the IDb[9:2, 0]# and IDS# signals on the second clock.

A.1.43 LEN[2:0]# (I/O)

The Data Length (LEN[2:0]#) signals are transmitted using REQb[2:0]# signals by the requesting agent in the second clock of Request Phase. LEN[2:0]# defines the length of the data transfer requested by the requesting agent as shown in [Table A-9](#). The LEN[2:0]#, HITM#, and RS[2:0]# signals together define the length of the actual data transfer.

Table A-9. Length of Data Transfers

LEN[2:0]#	Length
000	0 – 8 bytes
001	16 bytes
010	32 bytes
011	64 bytes
100	128 bytes
101	Reserved
110	Reserved
111	Reserved

A.1.44 LINT[1:0] (I)

LINT[1:0] are local interrupt signals. These pins are disabled after RESET#. LINT[0] is typically software configured as INT, an 8259-compatible maskable interrupt request signal. LINT[1] is typically software configured as NMI, a non-maskable interrupt. Both signals are asynchronous inputs.

A.1.45 LOCK# (I/O)

LOCK# is no connect and is ignored in the processor system environment.



A.1.46 NMI (I)

The NMI signal is the Non-maskable Interrupt signal. Asserting NMI causes an interrupt with an internally supplied vector value of 2. An external interrupt-acknowledge transaction is not generated. If NMI is asserted during the execution of an NMI service routine, it remains pending and is recognized after the EOI is executed by the NMI service routine. At most, one assertion of NMI is held pending.

NMI is rising-edge sensitive. Recognition of NMI is guaranteed in a specific clock if it is asserted synchronously and meets the setup and hold times. If asserted asynchronously, asserted and deasserted pulse widths of NMI must be a minimum of two clocks. This signal must be software configured to be used either as NMI or as another local interrupt (LINT1 pin).

A.1.47 OWN# (I/O)

The Guaranteed Cache Line Ownership (OWN#) signal is driven to the bus on the second clock of the Request Phase on the Ab[5]# pin. OWN# is asserted if cache line ownership is guaranteed. This allows a memory controller to ignore memory updates due to implicit writebacks.

A.1.48 PMI # (I)

The Platform Management Interrupt (PMI#) signal triggers the highest priority interrupt to the processor. PMI# is usually used by the system to trigger system events that will be handled by platform specific firmware.

A.1.49 PWRGOOD (I)

The Power Good (PWRGOOD) signal must be deasserted (L) during power-on, and must be asserted (H) after RESET# is first asserted by the system.

A.1.50 REQ[5:0]# (I/O)

The REQ[5:0]# are the Request Command signals. They are asserted by the current bus owner in both clocks of the Request Phase. In the first clock, the REQa[5:0]# signals define the transaction type to a level of detail that is sufficient to begin a snoop request. In the second clock, REQb[5:0]# signals carry additional information to define the complete transaction type. REQb[4:3]# signals transmit DSZ[1:0]# or the data transfer information of the requestor for transactions that involve data transfer. REQb[2:0]# signals transmit LEN[2:0]# (the data transfer length information). In both clocks, REQ[5:0]# and ADS# are protected by parity RP#.

All receiving agents observe the REQ[5:0]# signals to determine the transaction type and participate in the transaction as necessary, as shown in [Table A-10](#).

Table A-10. Transaction Types Defined by REQa#/REQb# Signals

Transaction	REQa[5:0]#						REQb[5:0]#					
	5	4	3	2	1	0	5	4	3	2	1	0
Deferred Reply	0	0	0	0	0	0	0	x	x	x	x	x
Reserved	0	0	0	0	0	1	0	x	x	x	x	x
Interrupt Acknowledge	0	0	1	0	0	0	0	DSZ[1:0]#		0	0	0
Special Transactions	0	0	1	0	0	0	0	DSZ[1:0]#		0	0	1
Reserved	0	0	1	0	0	0	0	DSZ[1:0]#		0	1	x
Reserved	0	0	1	0	0	1	0	DSZ[1:0]#		0	x	x
Interrupt	0	0	1	0	0	1	0	DSZ[1:0]#		1	0	0
Purge TC	0	0	1	0	0	1	0	DSZ[1:0]#		1	0	1
Reserved	0	0	1	0	0	1	0	DSZ[1:0]#		1	1	x
I/O Read	0	1	0	0	0	0	0	DSZ[1:0]#		x	x	x
I/O Write	0	1	0	0	0	1	0	DSZ[1:0]#		x	x	x
Reserved	0	1	1	0	0	x	0	DSZ[1:0]#		x	x	x
Memory Read & Invalidate	0	ASZ[1:0]#		0	1	0	0	DSZ[1:0]#		LEN[2:0]#		
Reserved	0	ASZ[1:0]#		0	1	1	0	DSZ[1:0]#		LEN[2:0]#		
Memory Read	0	ASZ[1:0]#		1	D/C#	0	0	DSZ[1:0]#		LEN[2:0]#		
Memory Read Current	1	ASZ[1:0]#		1	0	0	0	DSZ[1:0]#		LEN[2:0]#		
Reserved	1	ASZ[1:0]#		1	1	0	0	DSZ[1:0]#		LEN[2:0]#		
Memory Write	0	ASZ[1:0]#		1	WSNP#	1	0	DSZ[1:0]#		LEN[2:0]#		
Cache Line Replacement	1	ASZ[1:0]#		1	WSNP#	1	0	DSZ[1:0]#		0	0	0

A.1.51 RESET# (I)

Asserting the RESET# signal resets all processors to known states and invalidates all caches without writing back Modified (M state) lines. RESET# must remain asserted for one millisecond for a "warm" reset; for a power-on reset, RESET# must stay asserted for at least one millisecond after PWRGOOD and BCLKp have reached their proper specifications. On observing asserted RESET#, all system bus agents must deassert their outputs within two clocks.

A number of bus signals are sampled at the asserted-to-deasserted transition of RESET# for the power-on configuration.

Unless its outputs are tristated during power-on configuration, after asserted-to-deasserted transition of RESET#, the processor begins program execution at the reset-vector

A.1.52 RP# (I/O)

The Request Parity (RP#) signal is driven by the requesting agent, and provides parity protection for ADS# and REQ[5:0]#.

A correct parity signal is high if an even number of covered signals are low and low if an odd number of covered signals are low. This definition allows parity to be high when all covered signals are high.



A.1.53 RS[2:0]# (I)

The Response Status (RS[2:0]#) signals are driven by the responding agent (the agent responsible for completion of the transaction).

A.1.54 RSP# (I)

The Response Parity (RSP#) signal is driven by the responding agent (the agent responsible for completion of the current transaction) during assertion of RS[2:0]#, the signals for which RSP# provides parity protection.

A correct parity signal is high if an even number of covered signals are low and low if an odd number of covered signals are low. During the Idle state of RS[2:0]# (RS[2:0]#=000), RSP# is also high since it is not driven by any agent guaranteeing correct parity.

A.1.55 SBSY# (I/O)

The Strobe Bus Busy (SBSY#) signal is driven by the agent transferring data when it owns the strobe bus. SBSY# holds the strobe bus before the first DRDY# and between DRDY# assertions for a multiple clock data transfer. SBSY# is deasserted before DBSY# to allow the next data transfer agent to predrive the strobes before the data bus is released.

SBSY# is replicated three times to enable partitioning of data paths in the system agents. This copy of the Strobe Bus Busy signal (SBSY#) is an input as well as an output.

A.1.56 SBSY_C1# (O)

SBSY# is a copy of the Strobe Bus Busy signal. This copy of the Strobe Bus Busy signal (SBSY_C1#) is an output only.

A.1.57 SBSY_C2# (O)

SBSY# is a copy of the Strobe Bus Busy signal. This copy of the Strobe Bus Busy signal (SBSY_C2#) is an output only.

A.1.58 SPLCK# (I/O)

The Split Lock (SPLCK#) signal is driven in the second clock of the Request Phase on the Ab[6]# pin of the first transaction of a locked operation. It is driven to indicate that the locked operation will consist of four locked transactions.

A.1.59 STBn[7:0]# and STBp[7:0]# (I/O)

STBp[7:0]# and STBn[7:0]# (and DRDY#) are used to transfer data at the 2x transfer rate in lieu of BCLKp. They are driven by the data transfer agent with a tight skew relationship with respect to its corresponding bus signals, and are used by the receiving agent to capture valid data in its latches. This functions like an independent double frequency clock constructed from a falling edge of either STBp[7:0]# or STBn[7:0]#. The data is synchronized by DRDY#. Each strobe pair is associated with 16 data bus signals and two ECC signals as shown in [Table A-11](#).

Table A-11. STBp[7:0]# and STBn[7:0]# Associations

Strobe Bits	Data Bits	ECC Bits
STBp[7]#, STBn[7]#	D[127:112]#	DEP[15:14]#
STBp[6]#, STBn[6]#	D[111:96]#	DEP[13:12]#
STBp[5]#, STBn[5]#	D[95:80]#	DEP[11:10]#
STBp[4]#, STBn[4]#	D[79:64]#	DEP[9:8]#
STBp[3]#, STBn[3]#	D[63:48]#	DEP[7:6]#
STBp[2]#, STBn[2]#	D[47:32]#	DEP[5:4]#
STBp[1]#, STBn[1]#	D[31:16]#	DEP[3:2]#
STBp[0]#, STBn[0]#	D[15:0]#	DEP[1:0]#

A.1.60 TCK (I)

The Test Clock (TCK) signal provides the clock input for the IEEE 1149.1 compliant TAP.

A.1.61 TDI (I)

The Test Data In (TDI) signal transfers serial test data into the processor. TDI provides the serial input needed for IEEE 1149.1 compliant TAP.

A.1.62 TDO (O)

The Test Data Out (TDO) signal transfers serial test data out from the processor. TDO provides the serial output needed for IEEE 1149.1 compliant TAP.

A.1.63 THRMTRIP# (O)

The Thermal Trip (THRMTRIP#) signal protects the processor from catastrophic overheating by use of an internal thermal sensor. This sensor is set well above the normal operating temperature to ensure that there are no false trips. Data will be lost if the processor goes into thermal trip (signaled to the system by the assertion of the THRMTRIP# signal). Once THRMTRIP# is asserted, the platform must assert RESET# to protect the physical integrity of the processor.

A.1.64 THRMALERT# (O)

THRMALERT# is asserted when the measured temperature from the processor thermal diode equals or exceeds the temperature threshold data programmed in the high-temp (THIGH) or low-temp (TLOW) registers on the sensor. This signal can be used by the platform to implement thermal regulation features.

A.1.65 TMS (I)

The Test Mode Select (TMS) signal is an IEEE 1149.1 compliant TAP specification support signal used by debug tools.

A.1.66 TND# (I/O)

The TLB Purge Not Done (TND#) signal is asserted to delay completion of a TLB Purge instruction, even after the TLB Purge transaction completes on the system bus.



A.1.67 TRDY# (I)

The Target Ready (TRDY#) signal is asserted by the target to indicate that it is ready to receive a write or implicit writeback data transfer.

A.1.68 TRST# (I)

The TAP Reset (TRST#) signal is an IEEE 1149.1 compliant TAP support signal used by debug tools.

A.1.69 WSNP# (I/O)

The Write Snoop (WSNP#) signal indicates that snooping agents will snoop the memory write transaction

A.2 Signal Summaries

Table A-12 through Table A-15 list attributes of the processor output, input, and I/O signals.

Table A-12. Output Signals

Name	Active Level	Clock	Signal Group
CPUPRES#	Low	—	Platform
DBSY_C1#	Low	BCLKp	Data
DBSY_C2#	Low	BCLKp	Data
DRDY_C1#	Low	BCLKp	Data
DRDY_C2#	Low	BCLKp	Data
FERR#	Low	Asynchronous	PC Compatibility, IERR Mode
SBSY_C1#	Low	BCLKp	Data
SBSY_C2#	Low	BCLKp	Data
TDO	High	TCK	TAP
THRMTRIP#	Low	Asynchronous	Error
THRMALERT#	Low	Asynchronous	Error

Table A-13. Input Signals (Sheet 1 of 2)

Name	Active Level	Clock	Signal Group	Qualified
BPRI#	Low	BCLKp	Arbitration	Always
BR1#	Low	BCLKp	Arbitration	Always
BR2#	Low	BCLKp	Arbitration	Always
BR3#	Low	BCLKp	Arbitration	Always
BCLKp	High	—	Control	Always
BCLKn	High	—	Control	Always
D/C#	Low	BCLKp	System Bus	Request Phase (Mem Rd)
DEFER#	Low	BCLKp	Snoop	Snoop Phase
DHIT#	Low	BCLKp	System Bus	IDS# + 1
GSEQ#	Low	BCLKp	Snoop	Snoop Phase

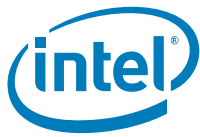

Table A-13. Input Signals (Sheet 2 of 2)

Name	Active Level	Clock	Signal Group	Qualified
ID[9:0]#	Low	BCLKp	Defer	IDS#, IDS# + 1
IDS#	Low	BCLKp	Defer	Always
INIT#	Low	Asynch	Exec Control	Always ¹
INT (LINT0)	High	Asynch	Exec Control	
IP[1:0]#	Low	BCLKp	System Bus	IDS# + 1
NMI (LINT1)	High	Asynch	Exec Control	
RESET#	Low	BCLKp	Control	Always
RS[2:0]#	Low	BCLKp	Response	Always
RSP#	Low	BCLKp	Response	Always
PMI#	Low	Asynch	Exec Control	
PWRGOOD	High	Asynch	Control	—
TCK	High	—	Diagnostic	Always
TDI	High	TCK	Diagnostic	Always
TMS	High	TCK	Diagnostic	Always
TRST#	Low	Asynch	Diagnostic	Always
TRDY#	Low	BCLKp	Response	Response Phase

Notes:

1. Synchronous assertion with asserted RS[2:0]# guarantees synchronization.

Table A-14. Input/Output Signals (Single Driver) (Sheet 1 of 2)

Name	Active Level	Clock	Signal Group	Qualified
A[49:3]#	Low	BCLKp	Request	ADS#, ADS# + 1
ADS#	Low	BCLKp	Request	Always
AP[1:0]#	Low	BCLKp	Request	ADS#, ADS# + 1
ASZ[1:0]#	Low	BCLKp	System Bus	ADS#
ATTR[3:0]#	Low	BCLKp	System Bus	ADS# + 1
BE[7:0]#	Low	BCLKp	System Bus	ADS# + 1
BRO#	Low	BCLKp	System Bus	Always
BPM[5:0]#	Low	BCLKp	Diagnostic	Always
CCL#	Low	BCLKp	System Bus	ADS# + 1
D[127:0]#	Low	BCLKp	Data	DRDY#
DBSY#	Low	BCLKp	Data	Always
D/C#	Low	BCLKp	System Bus	ADS#
DEN#	Low	BCLKp	System Bus	ADS# + 1
DEP[15:0]#	Low	BCLKp	System Bus	DRDY#
DID[9:0]#	Low	BCLKp	System Bus	ADS# + 1
DRDY#	Low	BCLKp	Data	Always
DPS#	Low	BCLKp	System Bus	ADS# + 1
DSZ[1:0]#	Low	BCLKp	System Bus	ADS# + 1
EXF[4:0]#	Low	BCLKp	System Bus	ADS# + 1
FCL#	Low	BCLKp	System Bus	ADS# + 1
LEN[2:0]#	Low	BCLKp	System Bus	ADS# + 1
OWN#	Low	BCLKp	System Bus	ADS# + 1



Table A-14. Input/Output Signals (Single Driver) (Sheet 2 of 2)

Name	Active Level	Clock	Signal Group	Qualified
REQ[5:0]#	Low	BCLKp	Request	ADS#, ADS# + 1
RP#	Low	BCLKp	Request	ADS#, ADS# + 1
SBSY#	Low	BCLKp	Data	Always
SPLCK#	Low	BCLKp	System Bus	ADS# + 1
STBn[7:0]#	Low	—	Data	Always
STBp[7:0]#	Low	—	Data	Always
WSNP#	Low	BCLKp	System Bus	ADS#

Table A-15. Input/Output Signals (Multiple Driver)

Name	Active Level	Clock	Signal Group	Qualified
BNR#	Low	BCLKp	System Bus	Always
BERR#	Low	BCLKp	Error	Always
BINIT#	Low	BCLKp	Error	Always
HIT#	Low	BCLKp	Snoop	Snoop Phase
HITM#	Low	BCLKp	Snoop	Snoop Phase
TND#	Low	BCLKp	Snoop	Always

§

